

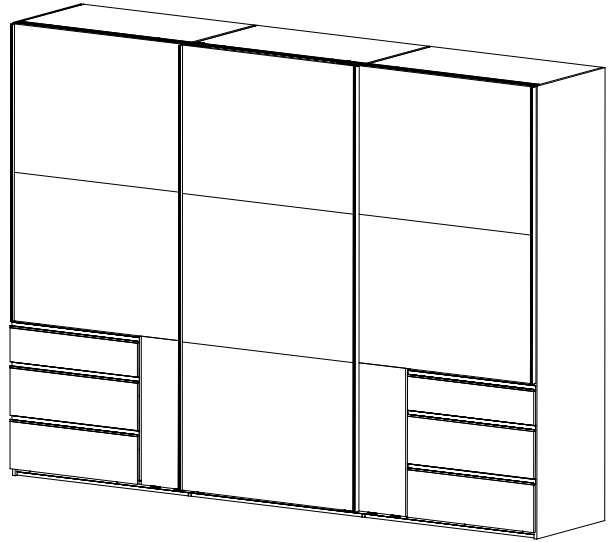

980712

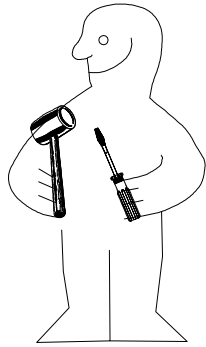

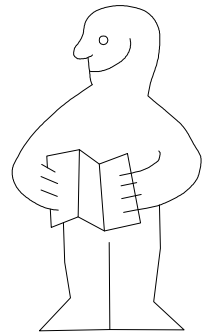

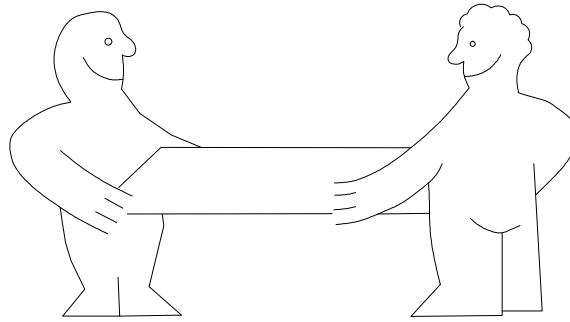
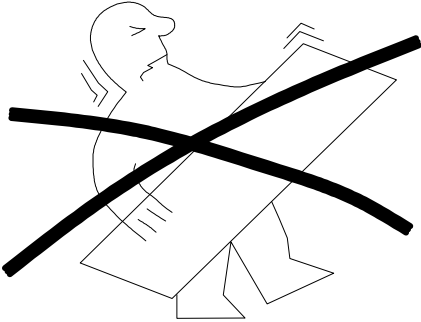



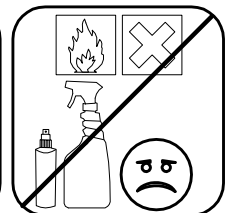
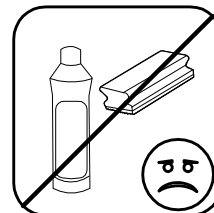
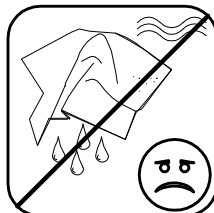
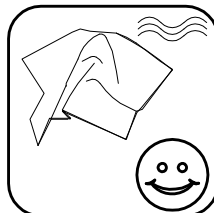
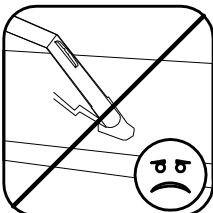
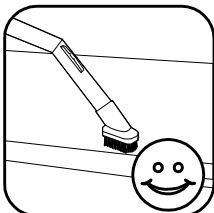
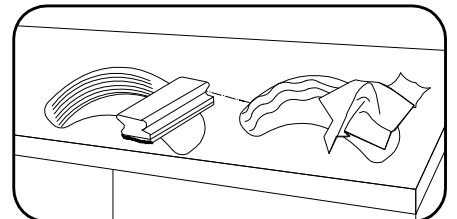
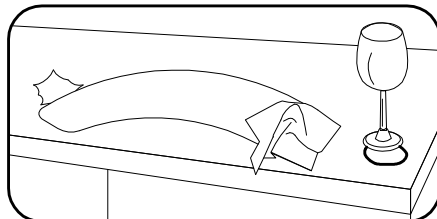
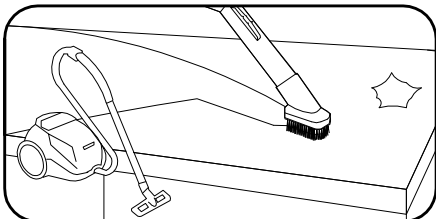
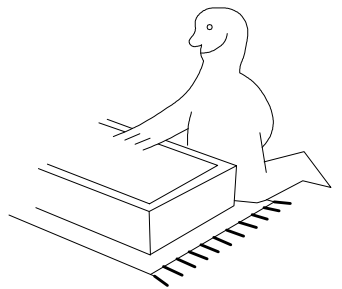
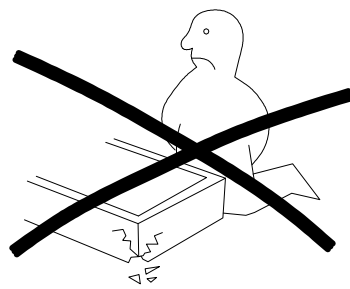
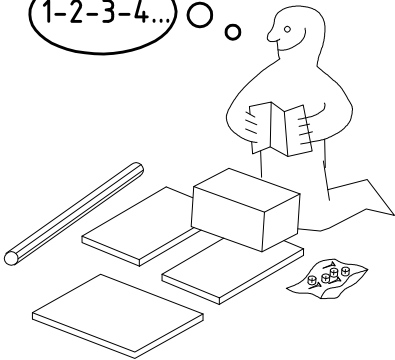



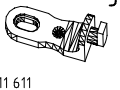
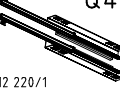
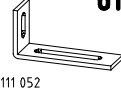
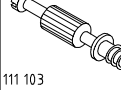



HSP 300 3trg ASK

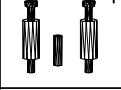
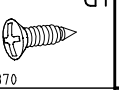
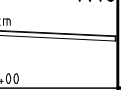

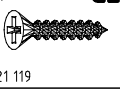
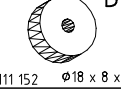
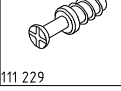
1-2-3-4... ○

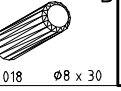

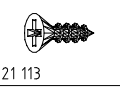
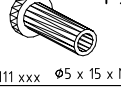

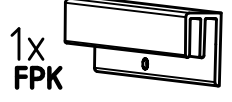
 A1 111 149	24x	 S0 111 300	15x	 K2 117 002	6x	 J2 111 611	9x	 Q45 112 220/1	6x	 o10 111 052	1x
 C 111 103	8x	 V12 111 xxx φ12	15x	 SBV 117 002	36x	 T1 112 055	30x	 T3 M6 x 10	12x	 SP13 121 122	4x
 F3	8x	 G1 121 370	42x	 K10 100cm	3x	 L8 111 607	20x	 G25 3,5 x 40 mm	14x	 D8 111 152	12x
 F 111 229	8x	 VB23 111 252	8x	 D 353 018	4x	 Z 163 007	4x	 G21 3 x 13 mm	24x	 F5 111 xxx	12x



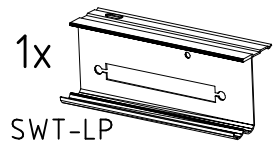



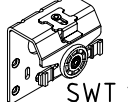

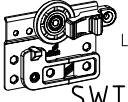
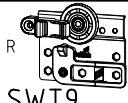

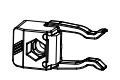

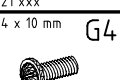
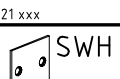

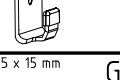
1x FPK
1453/1940/2430/2920/3408

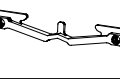

1x SWT-LP
1453/1940/2430/29203trg
/3410 SY

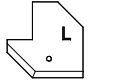
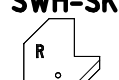
 SWT 1	2x
 SWT 2	2x
 SWT 8	1x
 SWT 9	1x

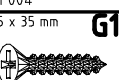
 SWT-ST	2x
 SWT-SM5 M4 x 13 mm	2x
 GH13 121 xxx	6x
 G43 M4 x 10 mm	6x
 121 xxx	6x
 SWH 6	2x
 SWH 7	4x
 G1 3,5 x 15 mm	2x
 121 370	2x
 SW-STM	1x

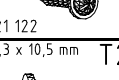
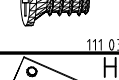
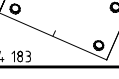
 SWH-SKL L	1x
 SWH-SKR R	1x
 G24 3,5 x 22 mm	10x
 G14 121 004	4x
 121 375	4x
 SP13 4 X 13mm	112x
 T2 121 122	34x
 H5 111 030	8x

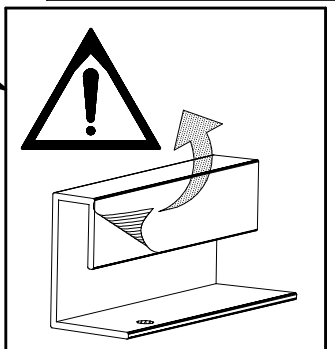
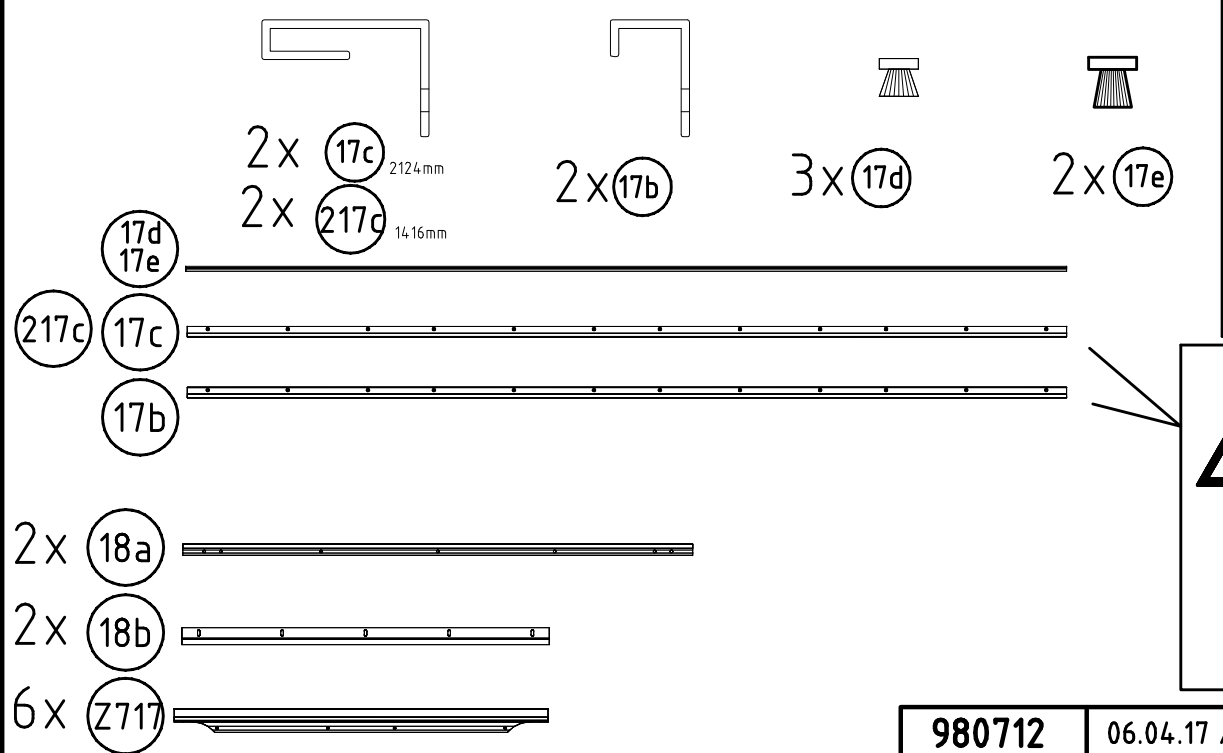
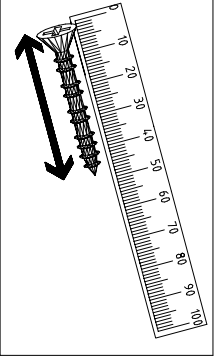
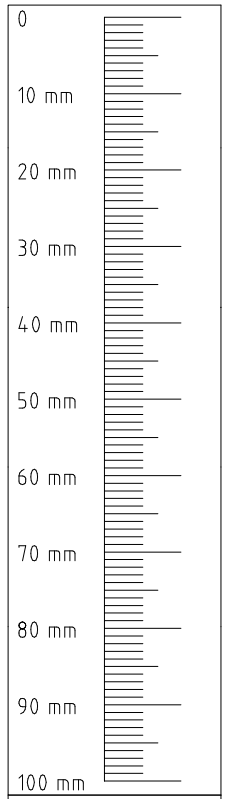
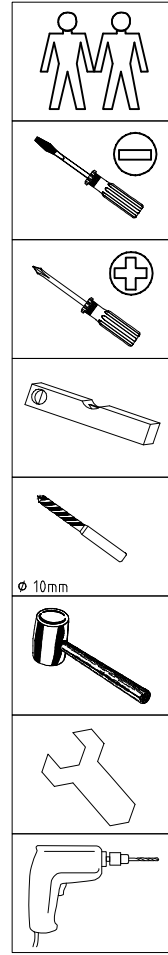

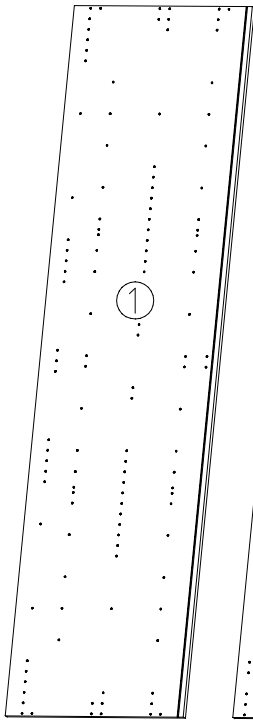

2160x577x15

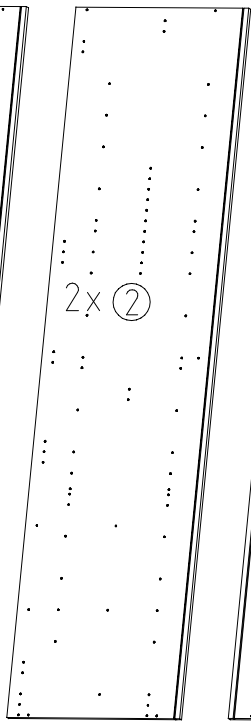

2160x560x15

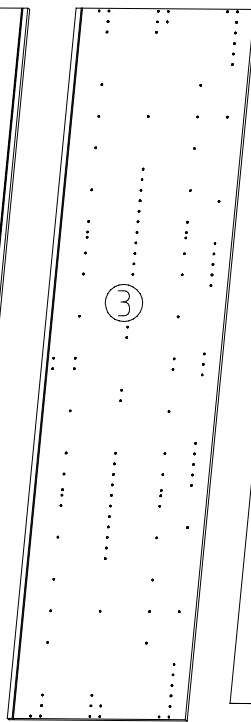

2160x577x15

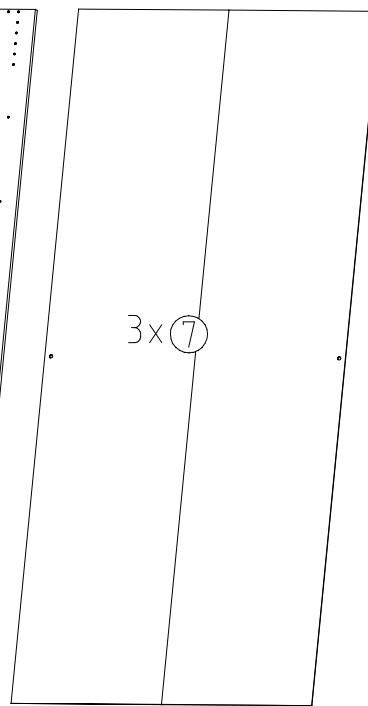

2111x973x2,5

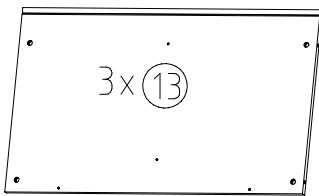

964x560x15

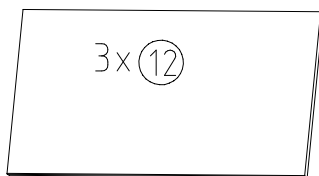

964x500x18

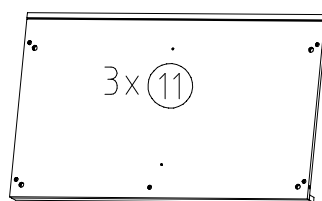

964x560x47

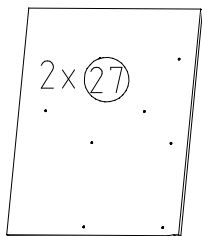

689x557x15

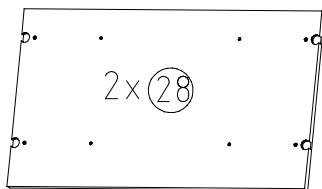

964x540x22



250x500x18

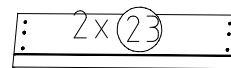

717x163x15

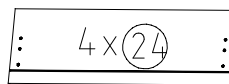

717x227x15

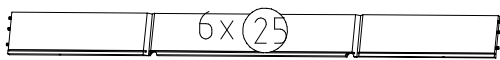

450/675/450x126x12

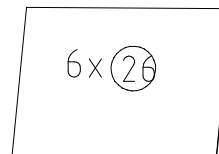

661x449x2,5

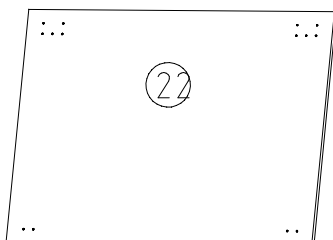

7x 990x708x15



2x 268x708x15

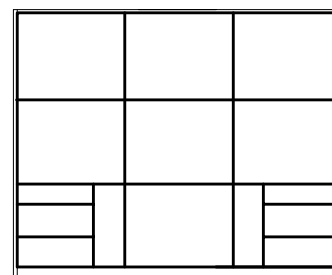

L M R

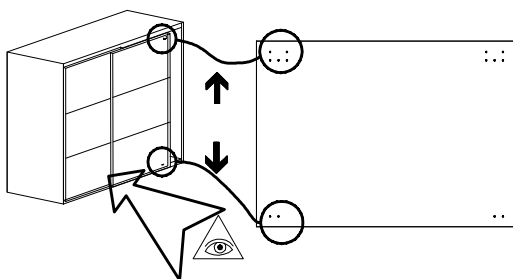

1

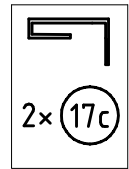
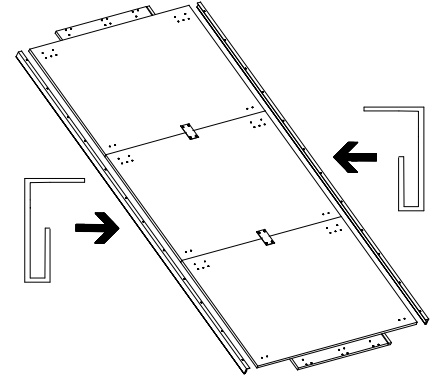
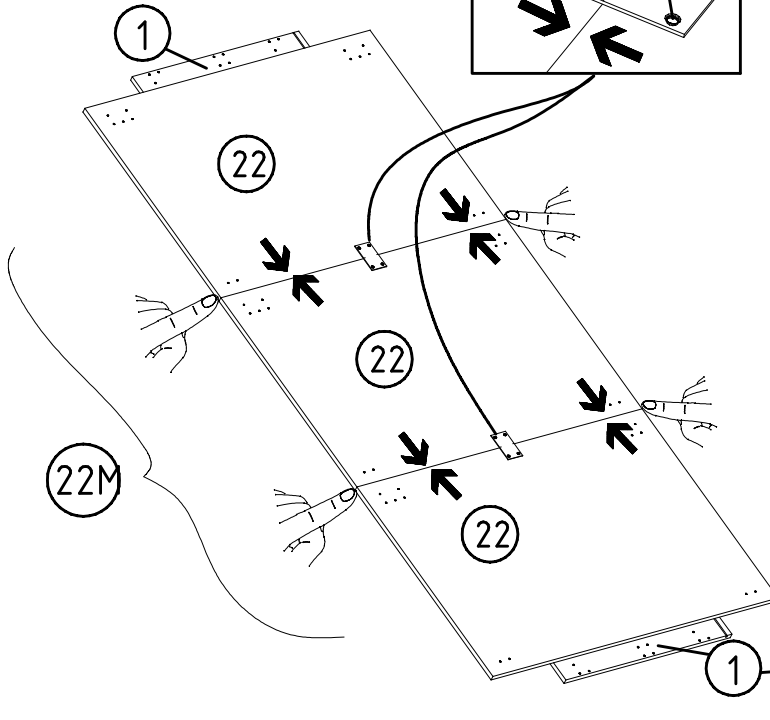
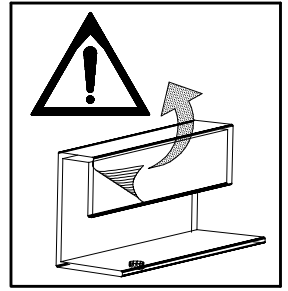
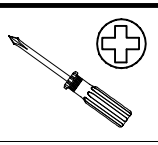
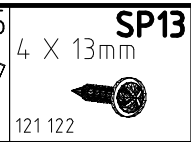
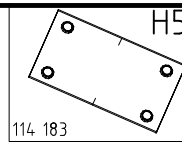
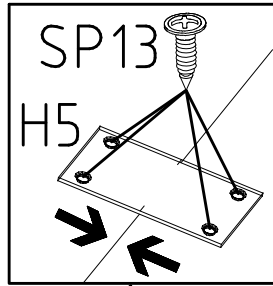
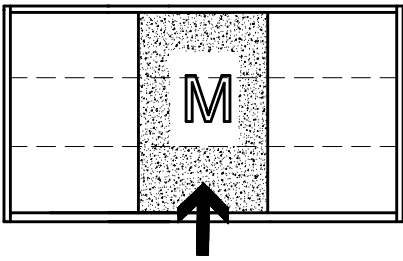

2

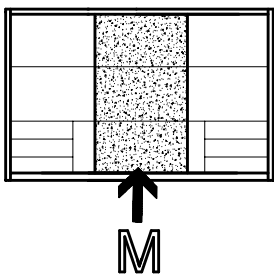
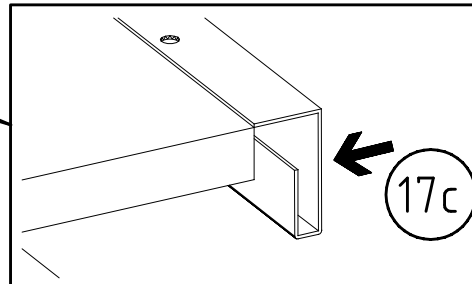
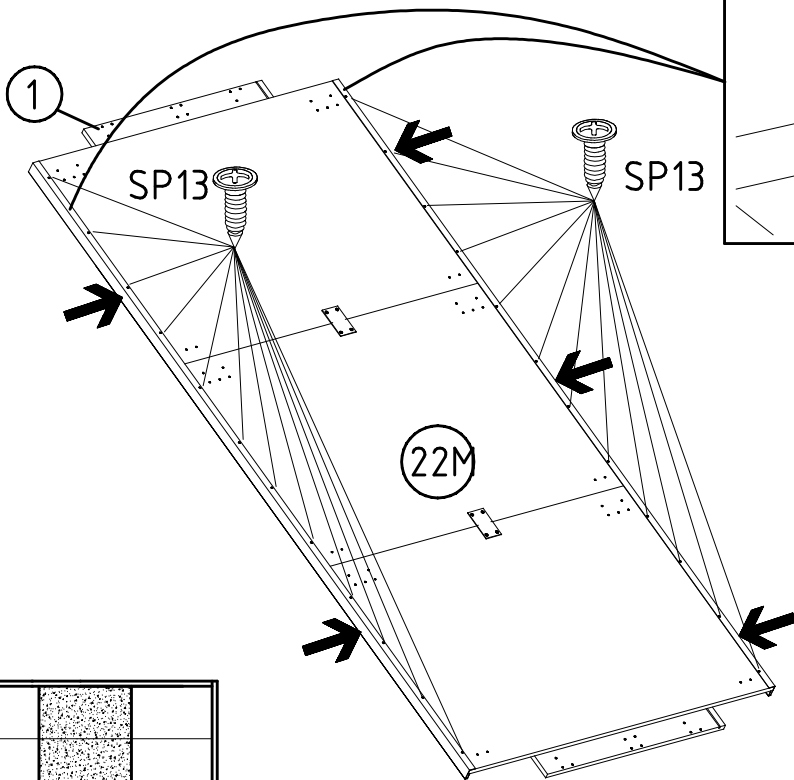
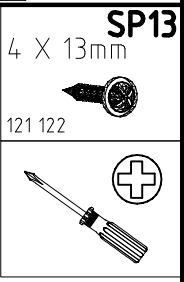

3

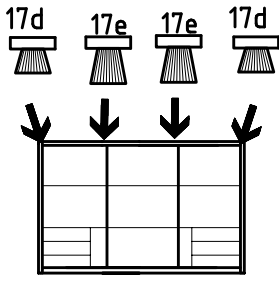
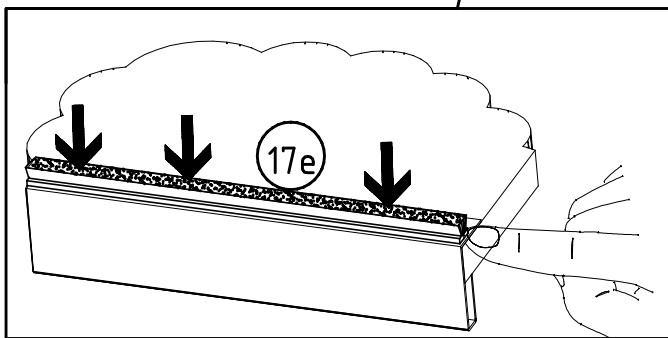
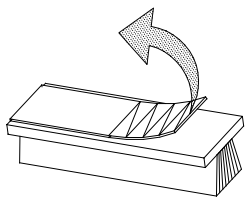
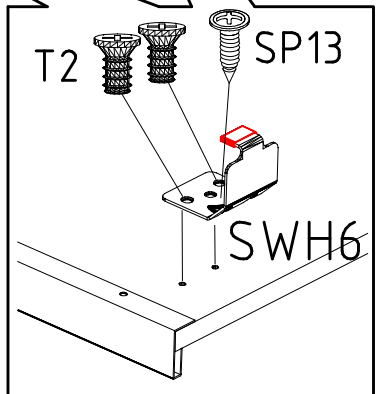
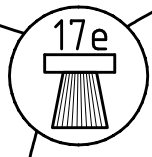
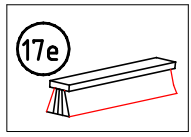
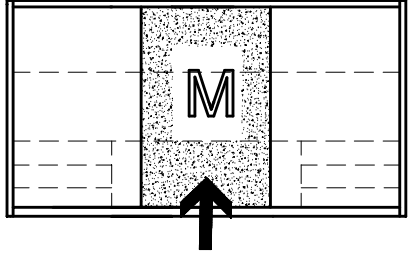
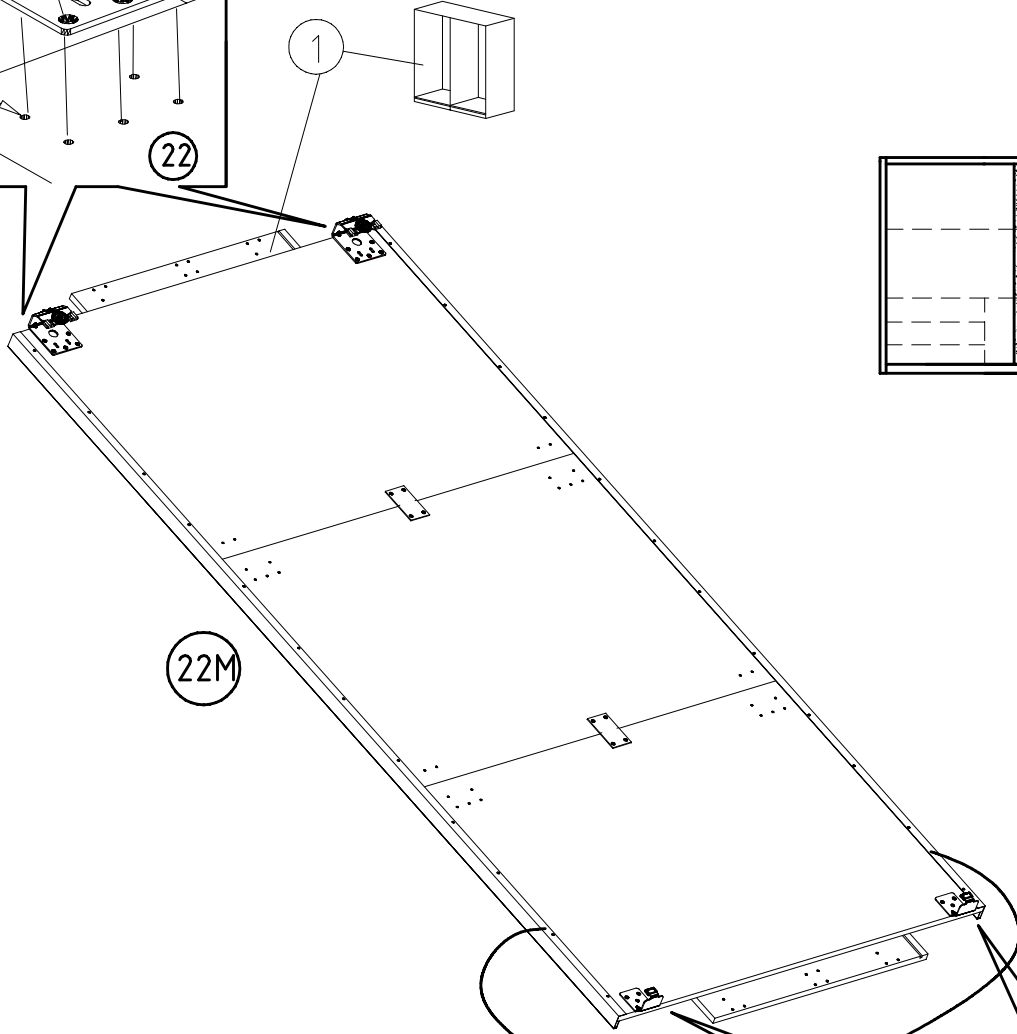
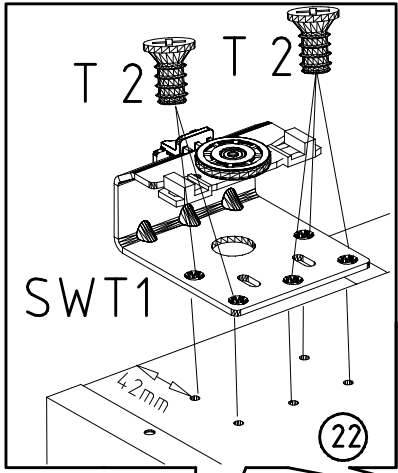
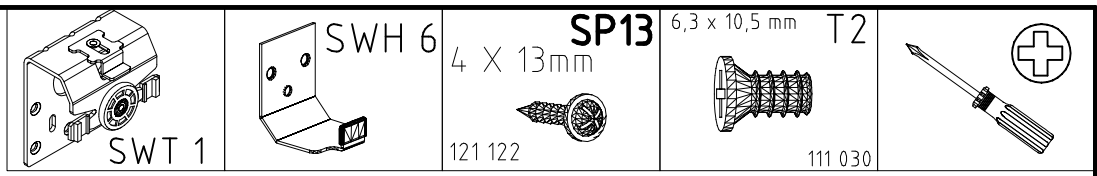

4

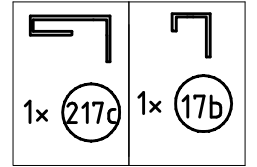
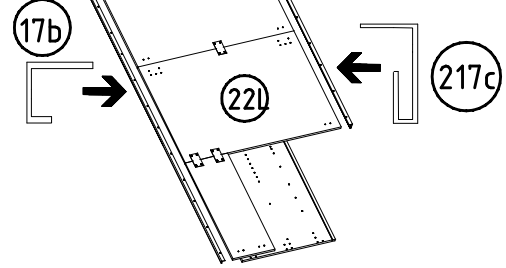
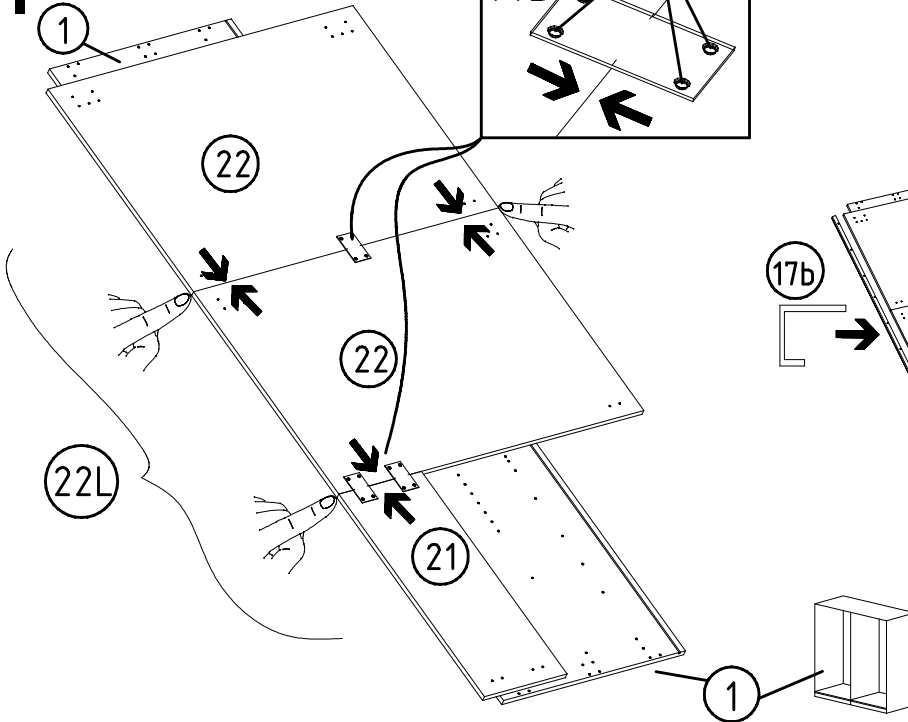
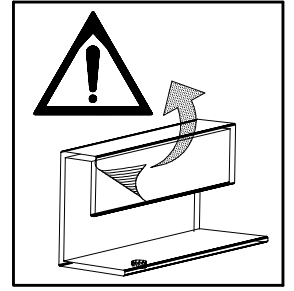
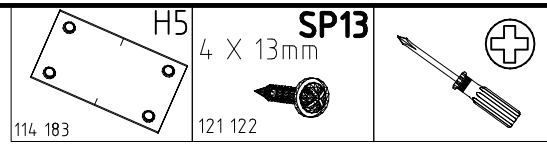
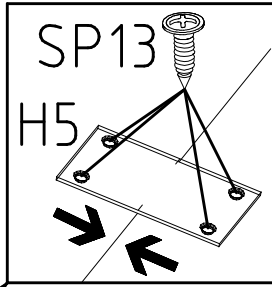
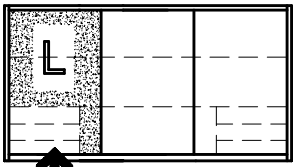

5

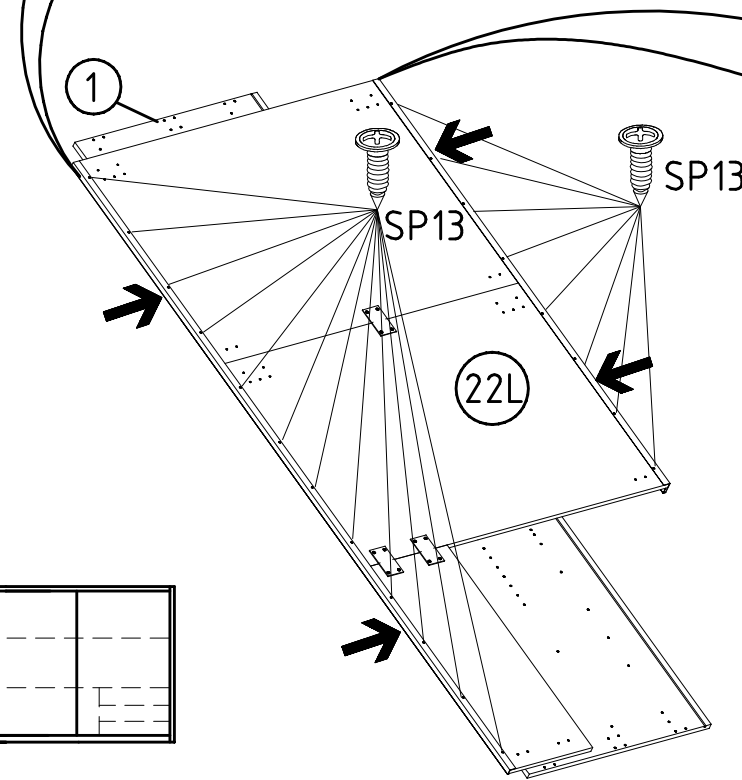
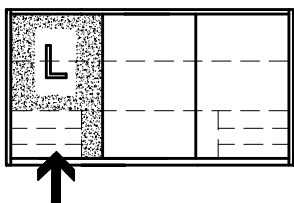
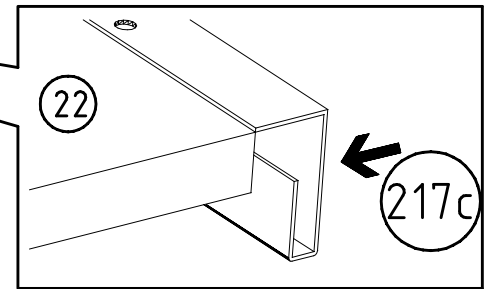
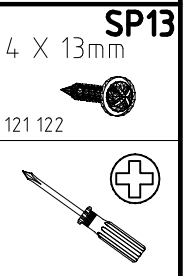
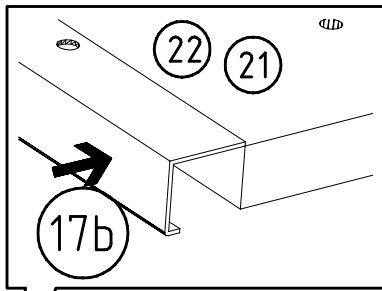

6

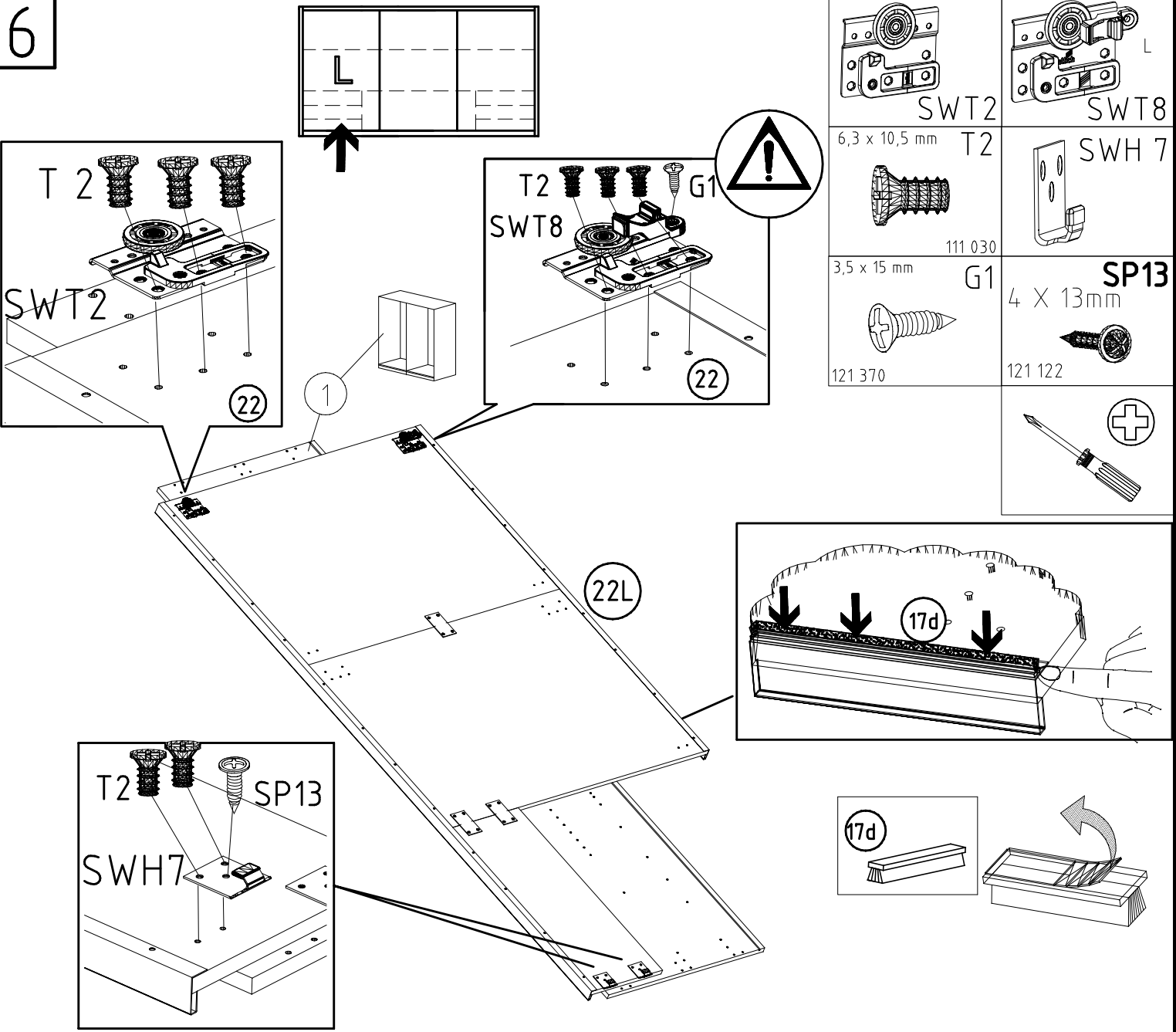

7

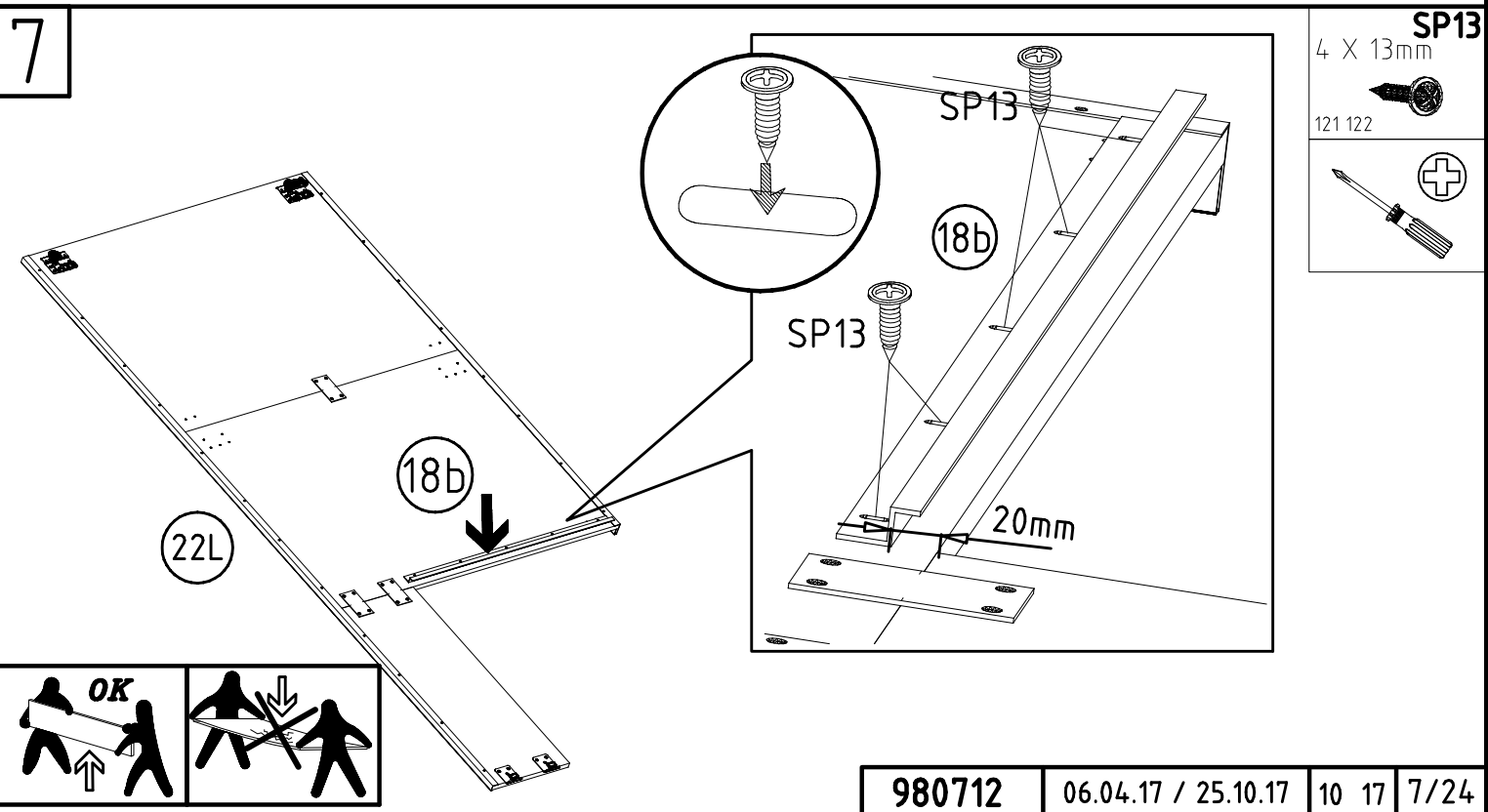

8

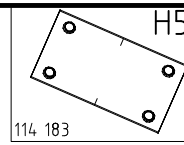
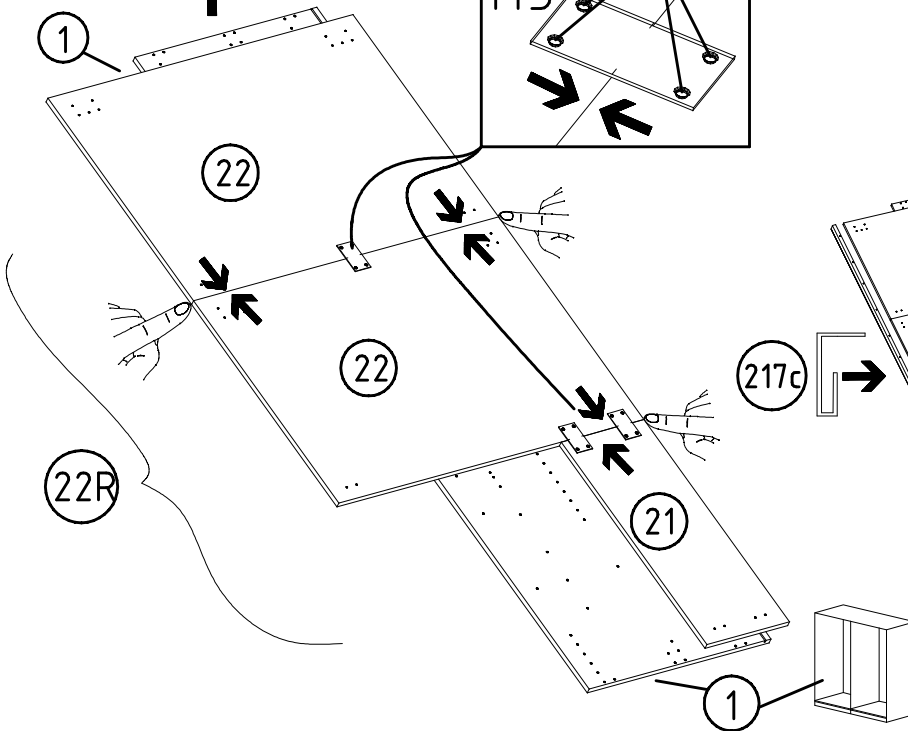
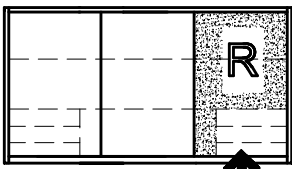

H5
4 X 13mm
SP13
121 122

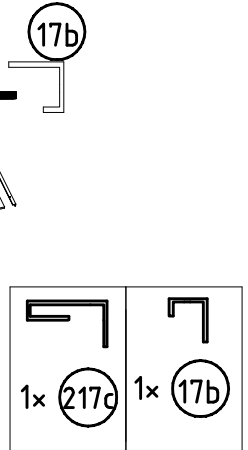
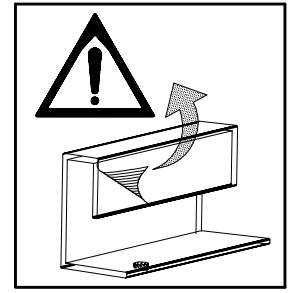
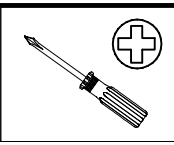

9

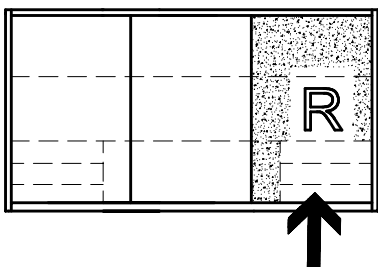
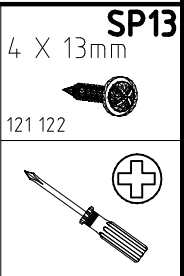
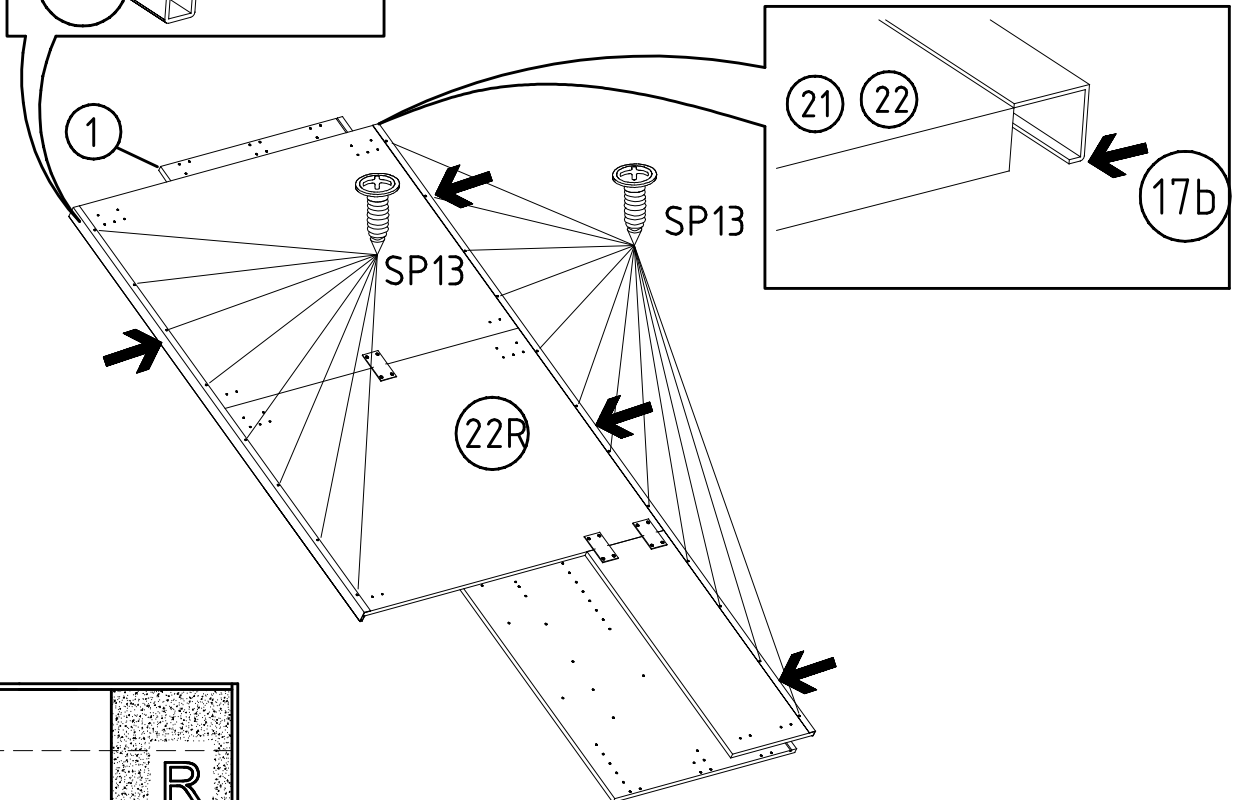
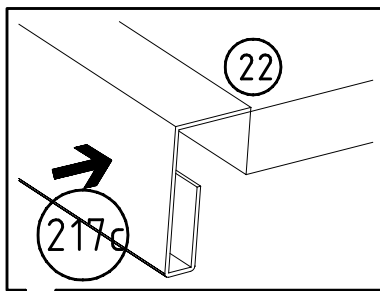

10

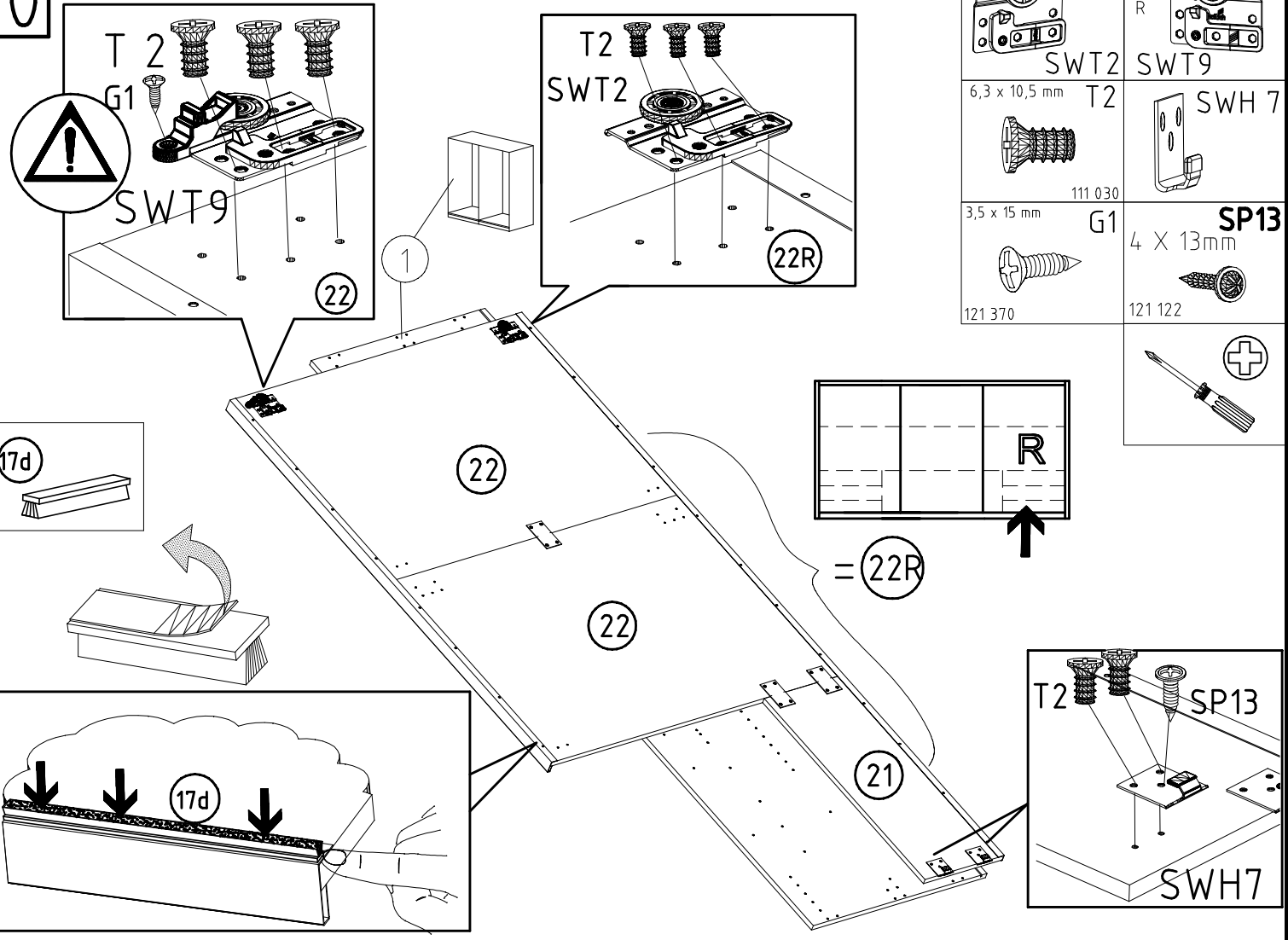

11

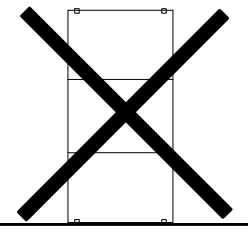
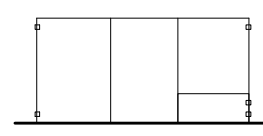
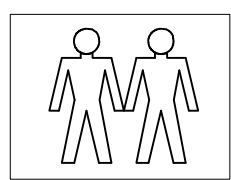
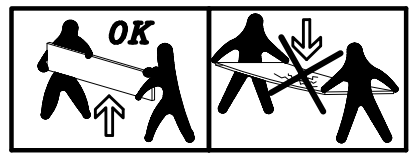
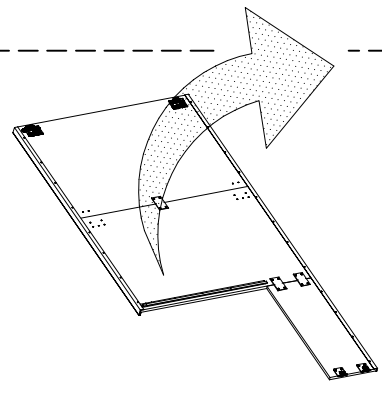
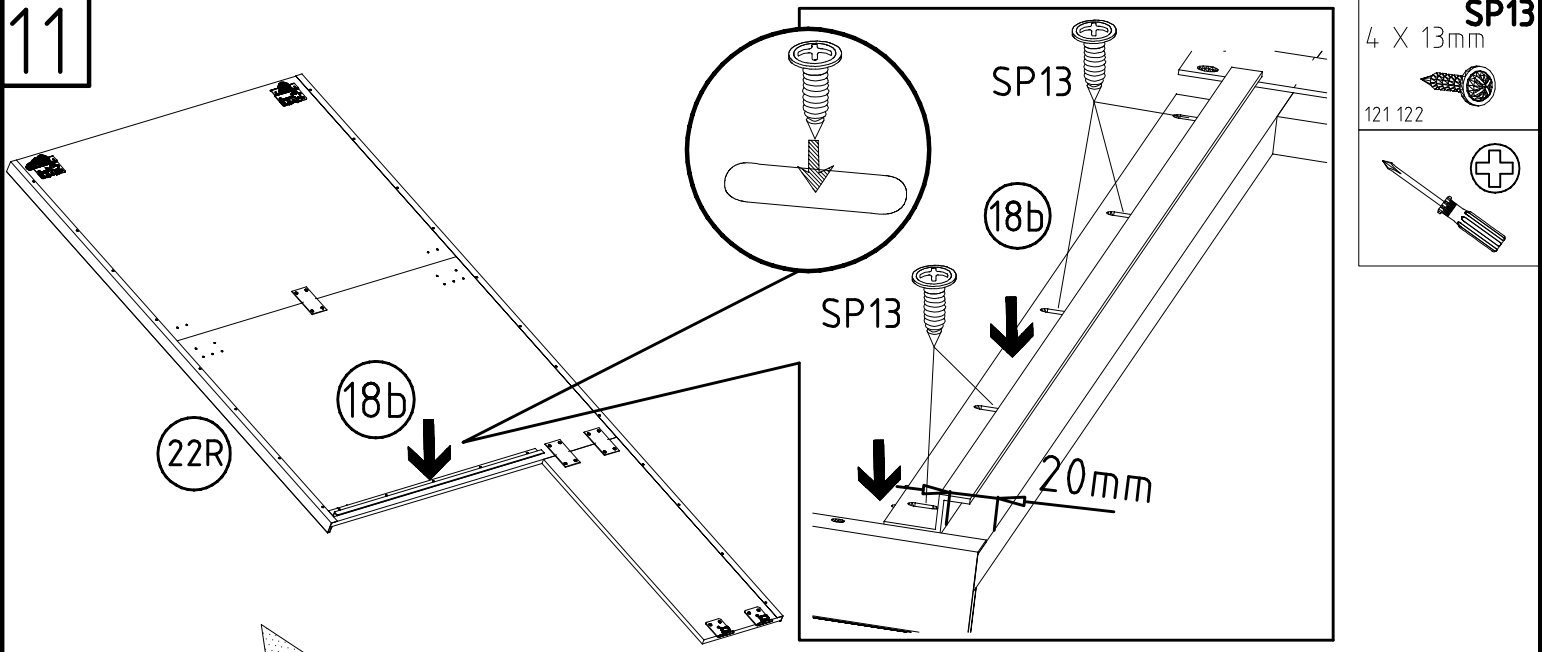

12

3,5 x 15 mm

G1

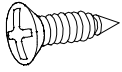

121 370

S0

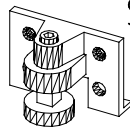

111 300

A1



111 149

14

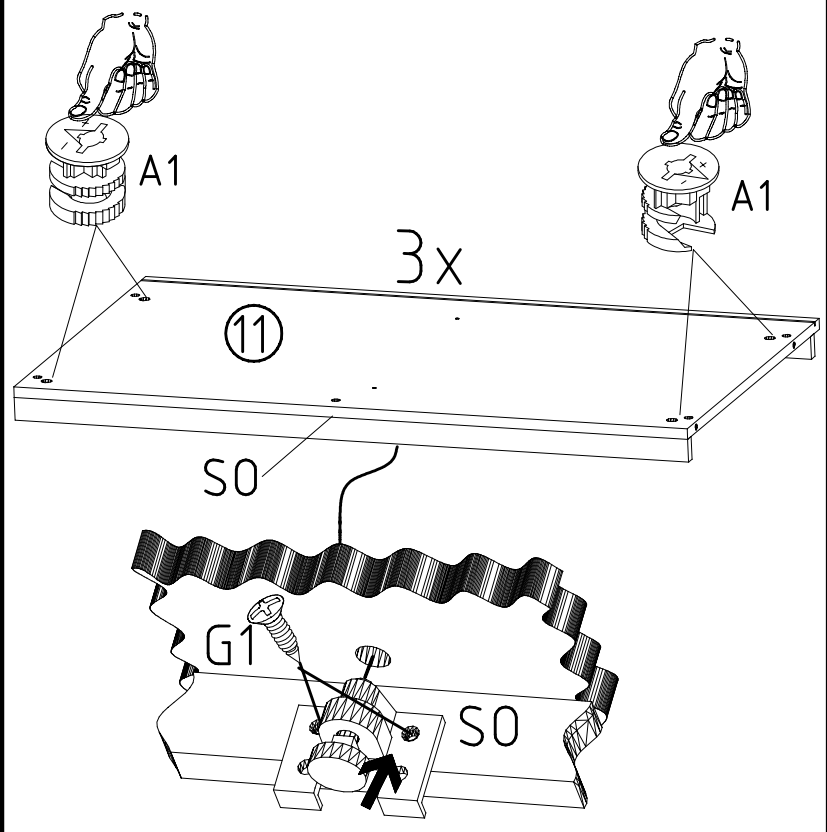

13

A1

111 149

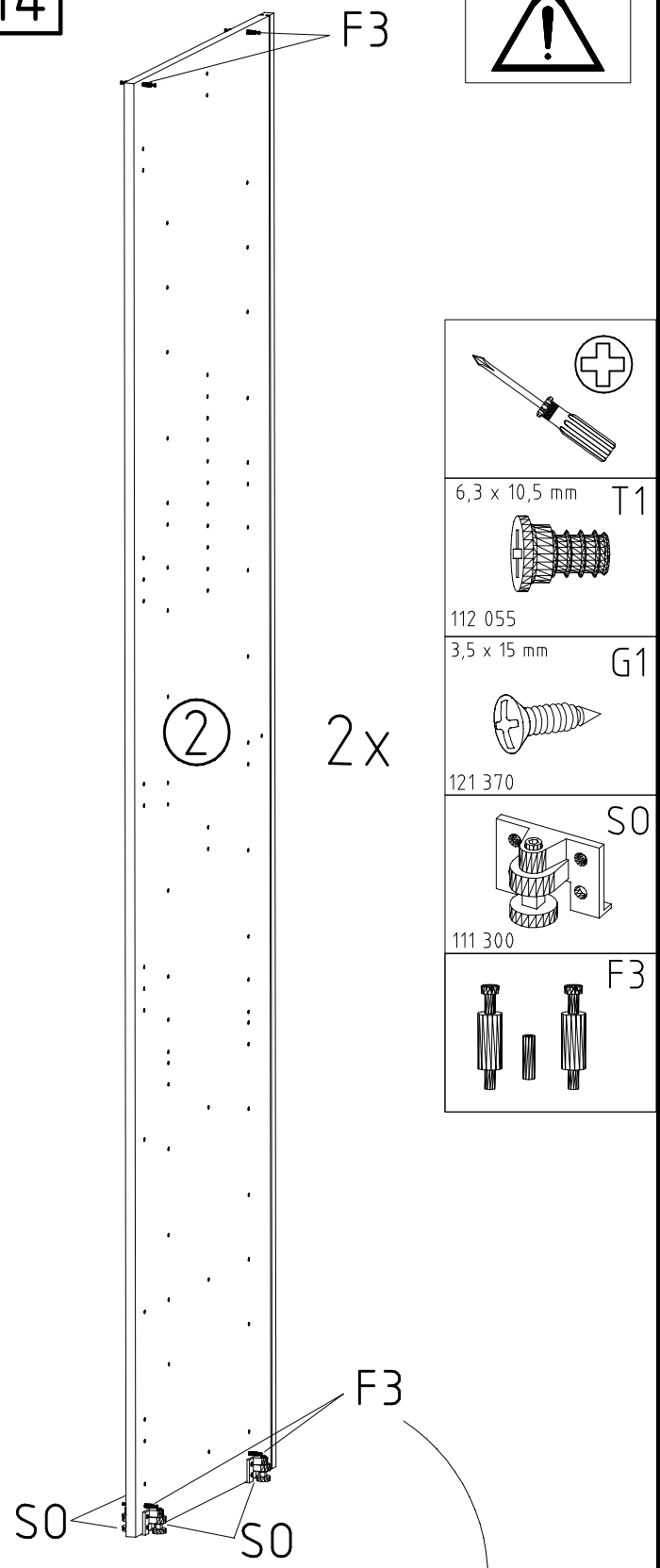
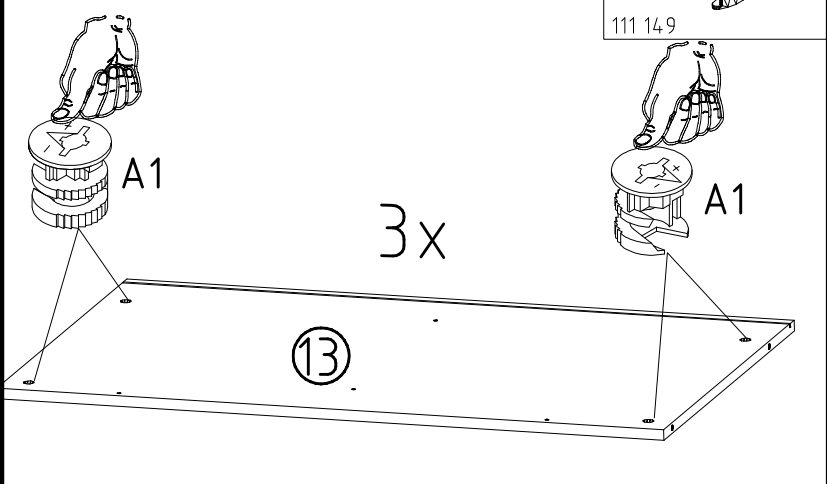

6,3 x 10,5 mm T1

112 055

3,5 x 15 mm G1

121 370

S0

111 300

F3

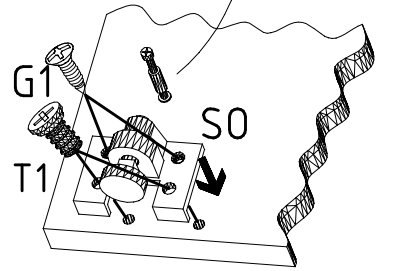
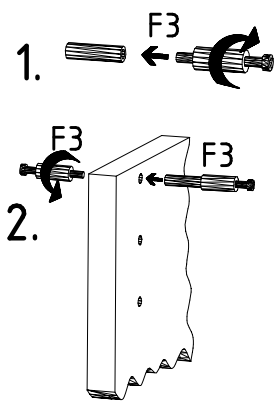

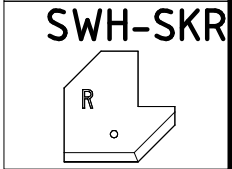
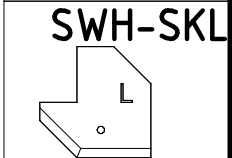
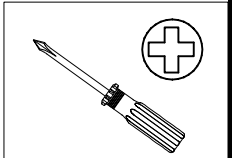
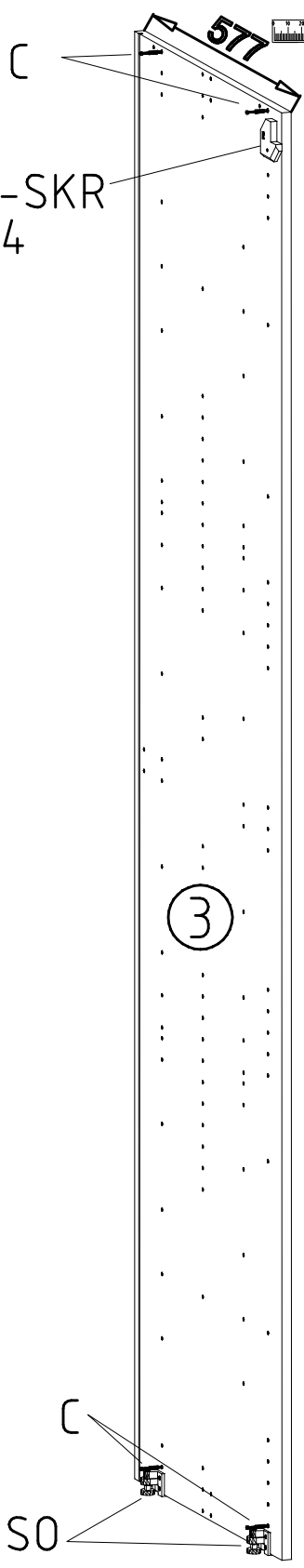
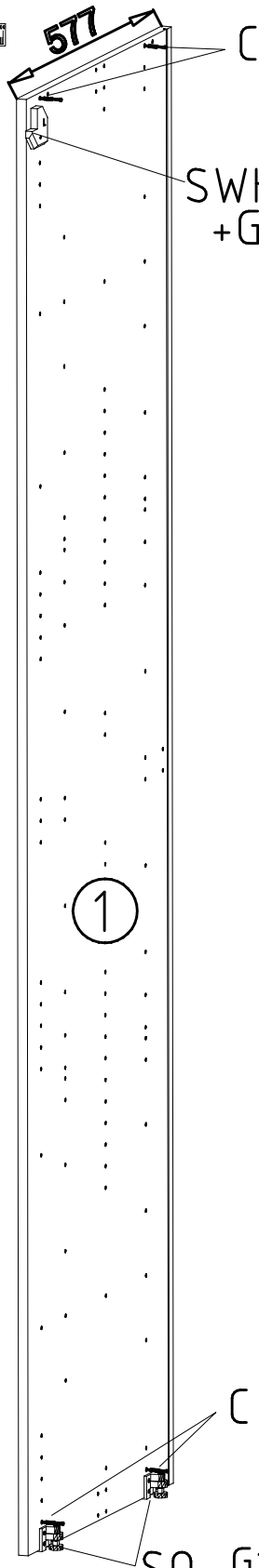
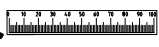
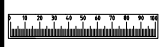
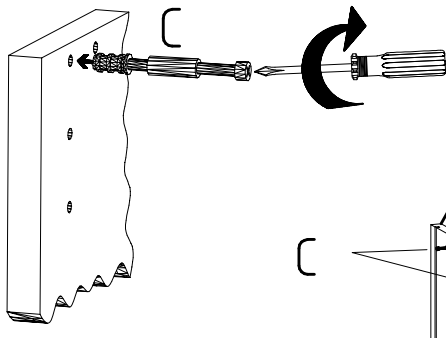
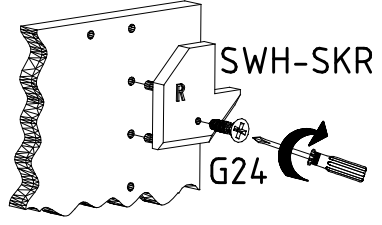
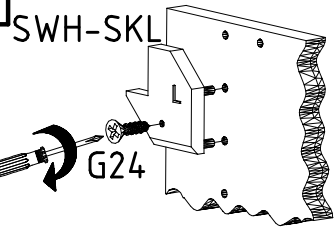

3,5 x 22 mm G24

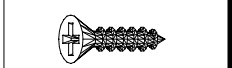

121 004

6,3 x 10,5 mm T1

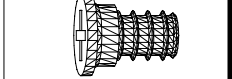

112 055

3,5 x 15 mm G1

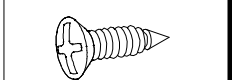

121 370

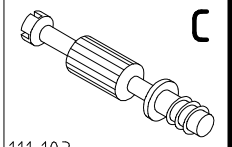

111 103

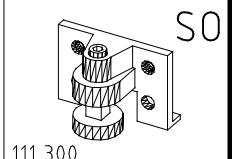

111 300

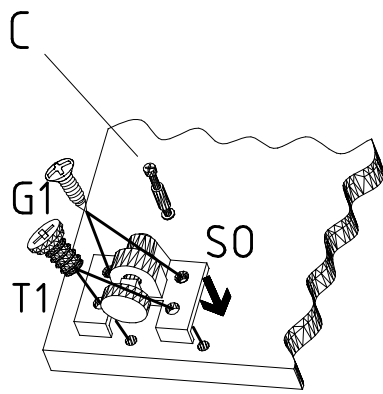

16

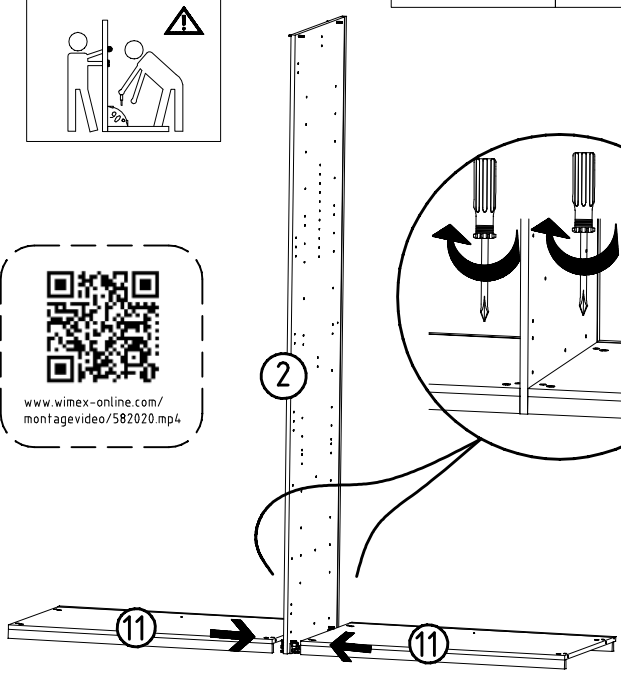
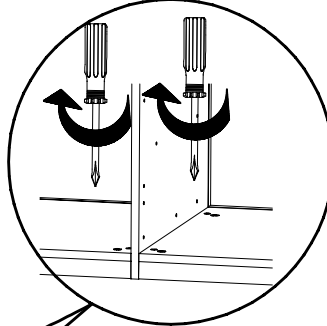
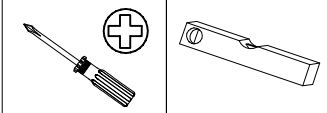

17

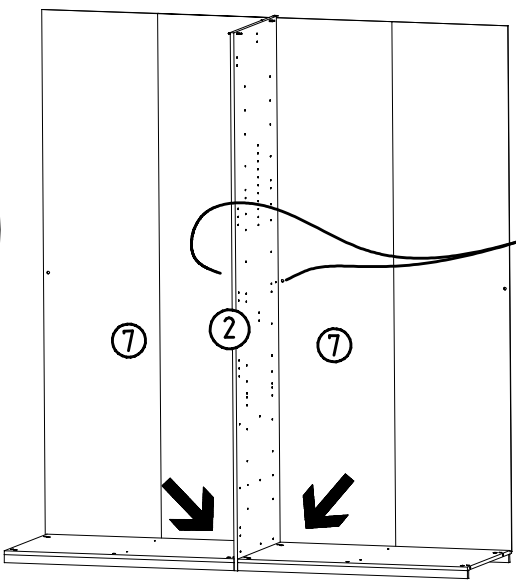
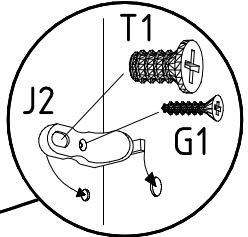
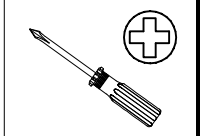

- 3,5 x 15 mm G1
- 121 370
- 111 611
- 6,3 x 10,5 mm T1
- 112 055

18

- 3,5 x 15 mm G1
- 121 370
- 6,3 x 10,5 mm T1
- 112 055
- 111 611

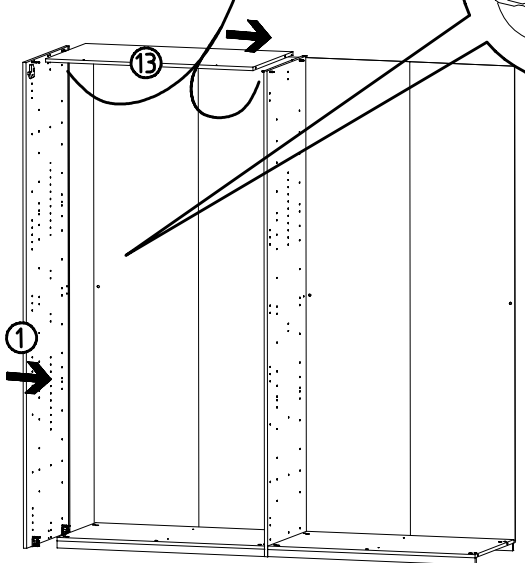
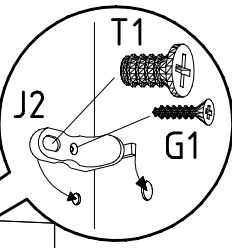
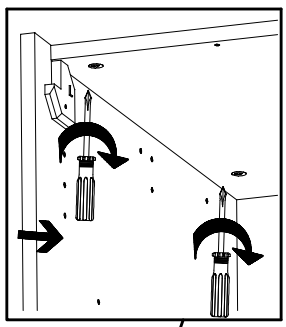

19

- 3,5 x 15 mm G1
- 121 370
- 6,3 x 10,5 mm T1
- 112 055
- 111 611

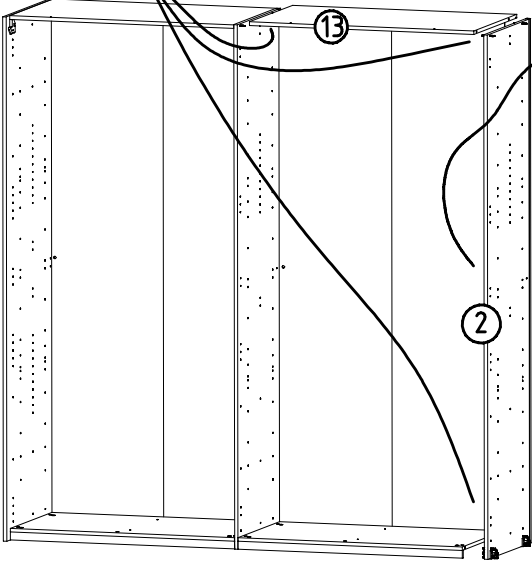
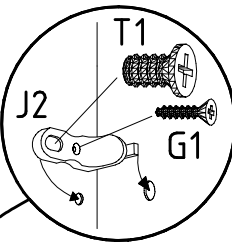
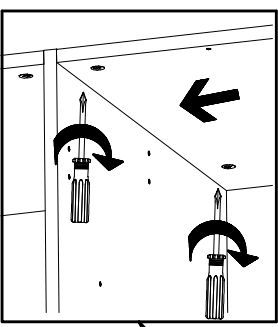

20

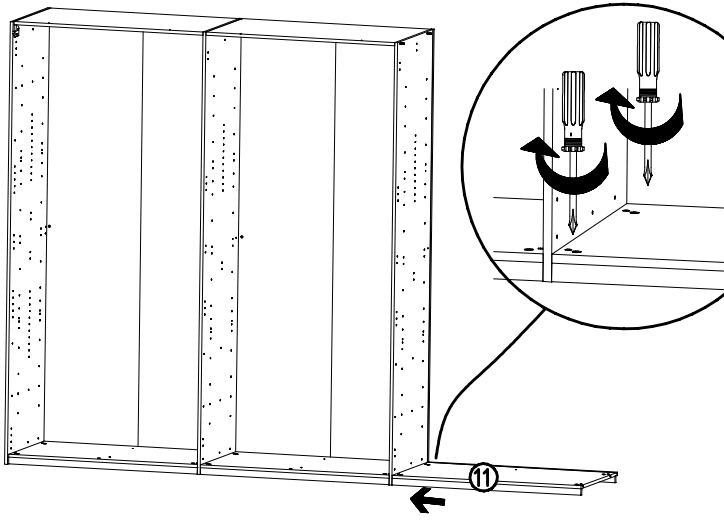
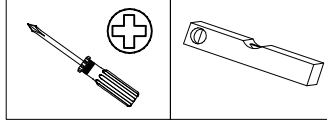
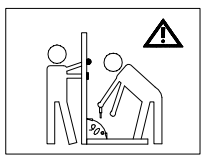

21

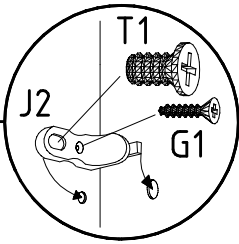
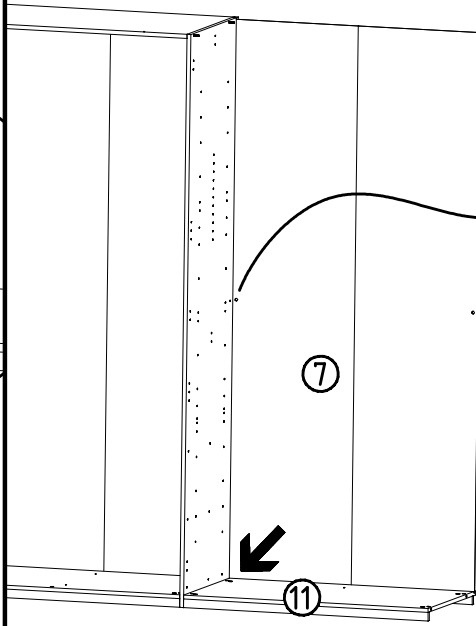
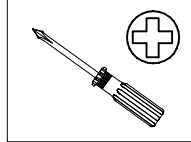

- 3,5 x 15 mm G1
- 121 370 J2
- 111 611 6,3 x 10,5 mm T1
- 112 055

22

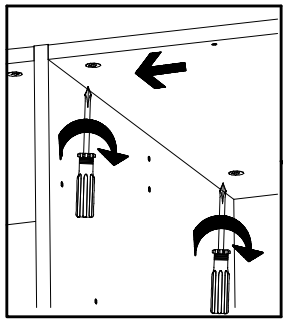

- 3,5 x 15 mm G1
- 121 370 J2
- 111 611 6,3 x 10,5 mm T1
- 112 055

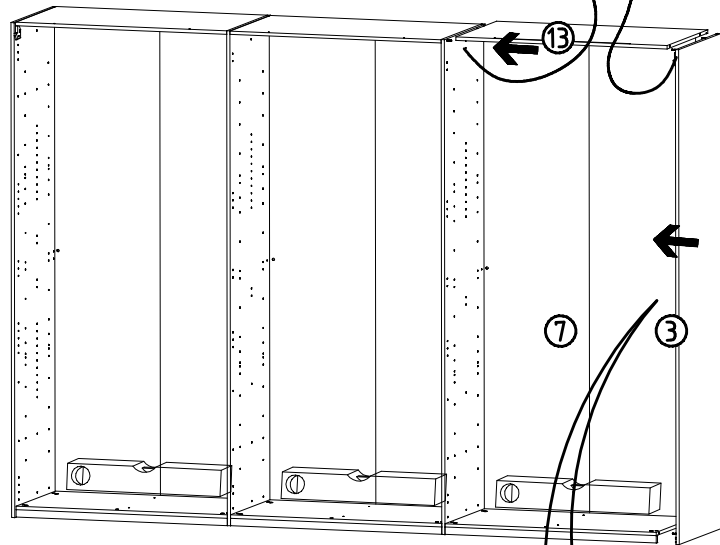

23

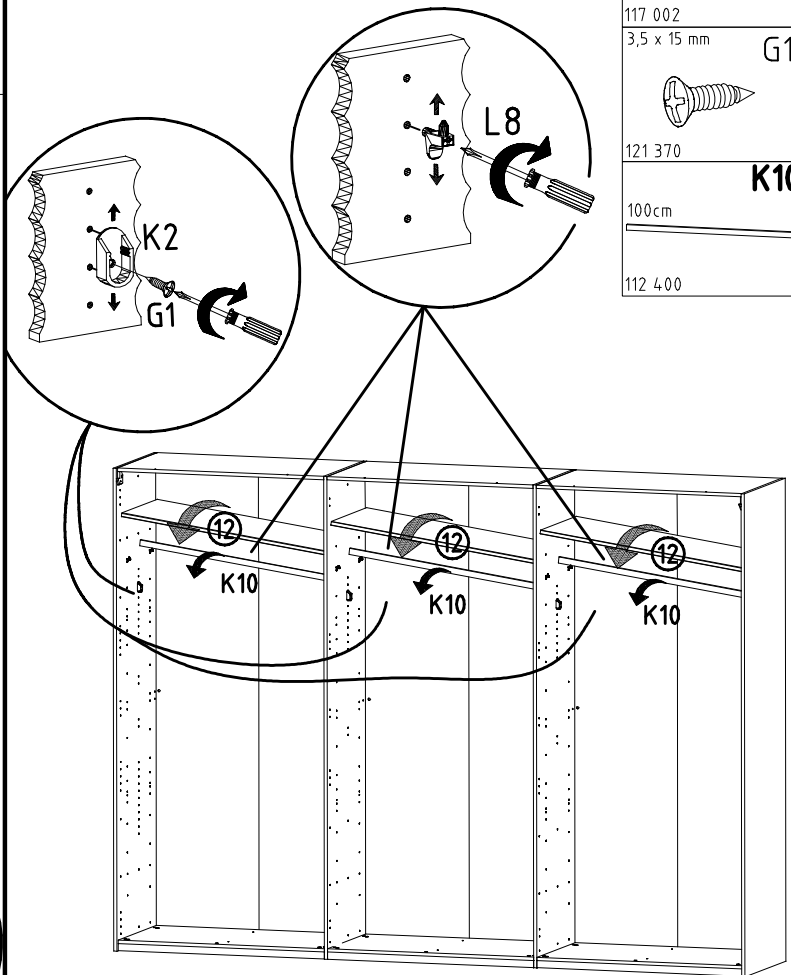

- L8
- 111 607
- K2
- 117 002 3,5 x 15 mm G1
- 121 370
- 100cm
- K10
- 112 400

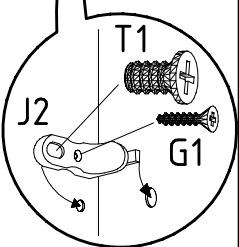
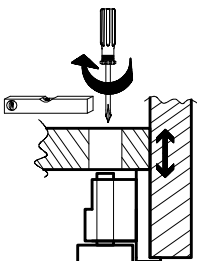

24

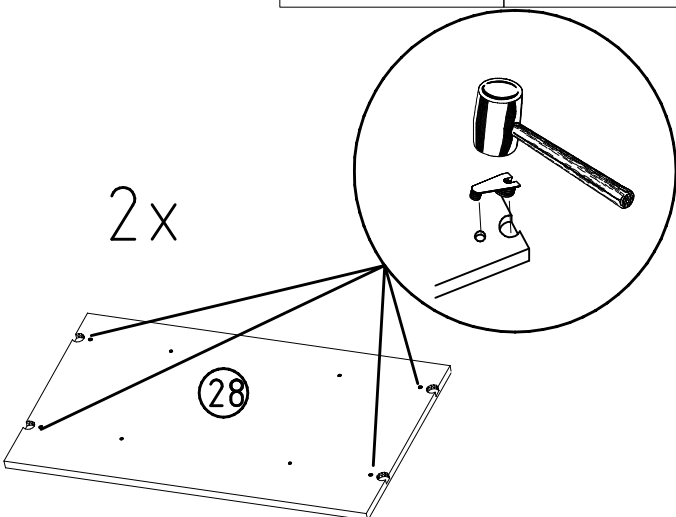
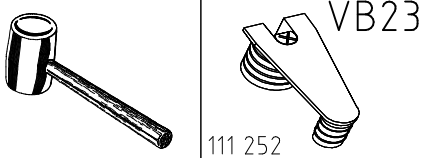

25

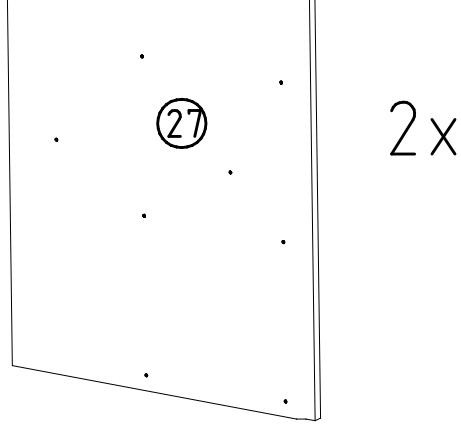
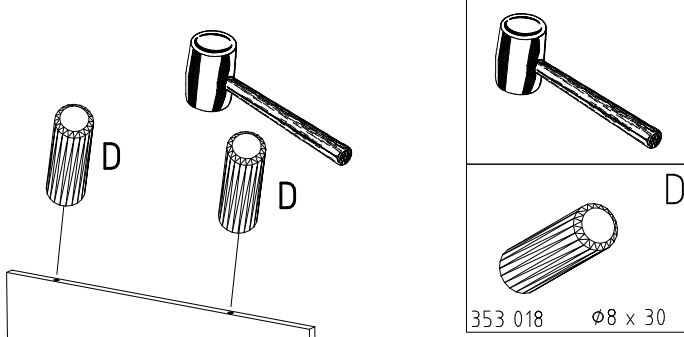

26

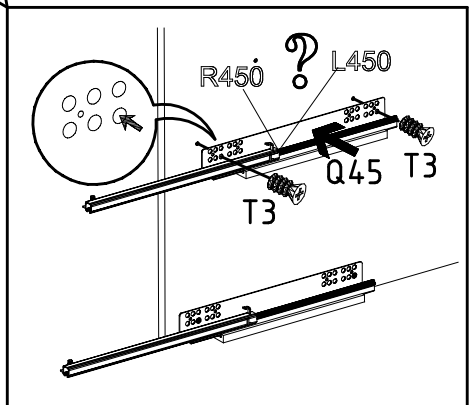
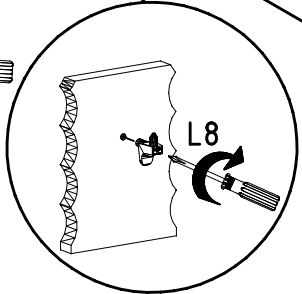
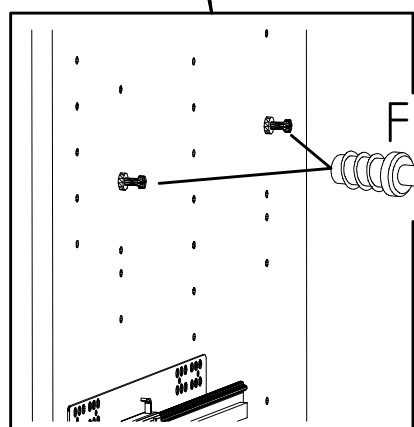
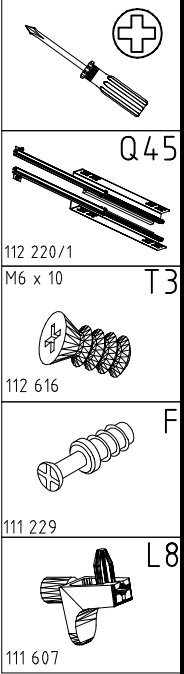
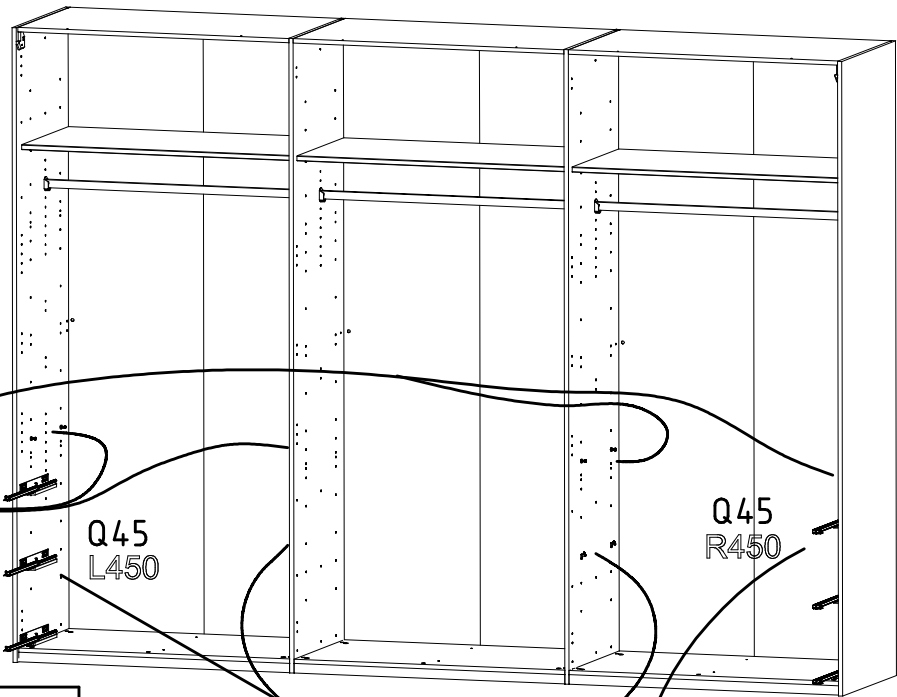

27

1x

1x

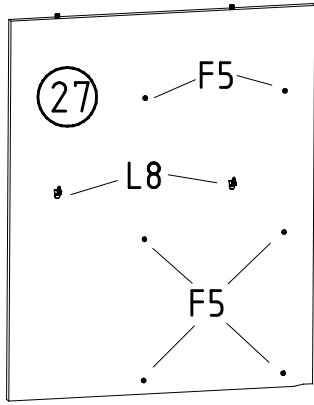

=27L

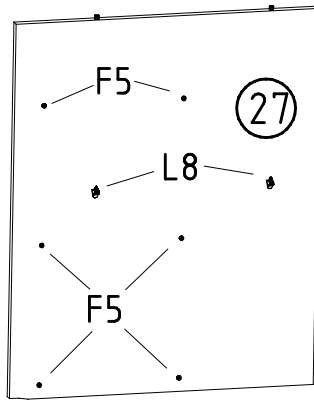

=27R

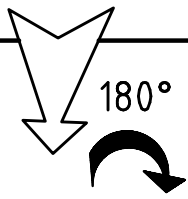
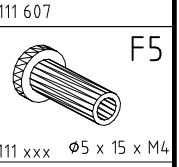
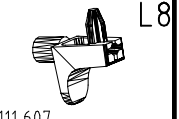
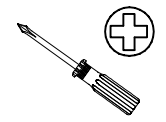
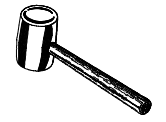
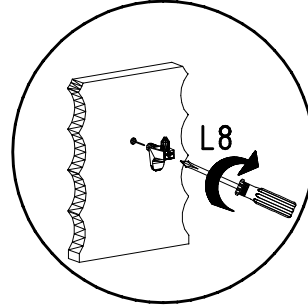
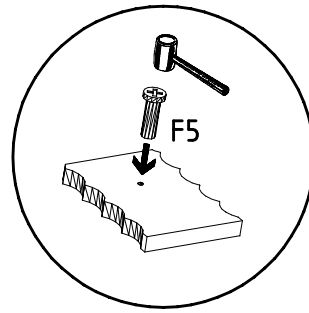

180°

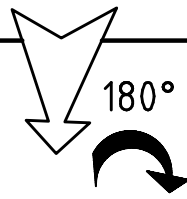

180°

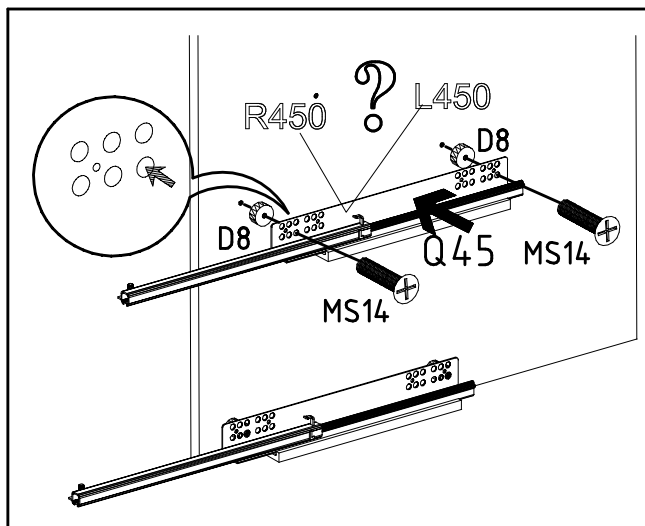
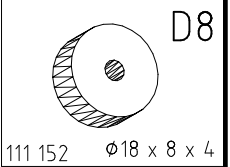
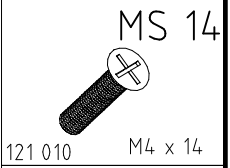
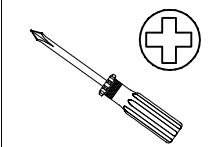
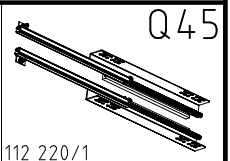
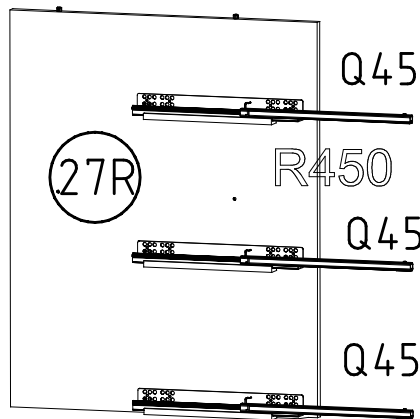
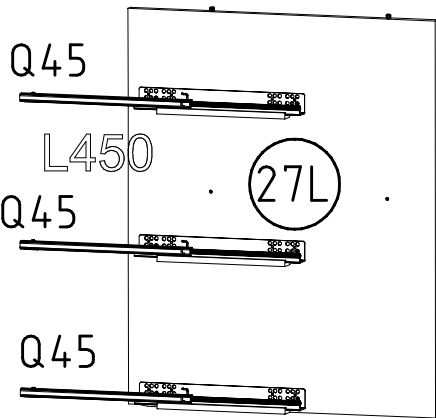

29

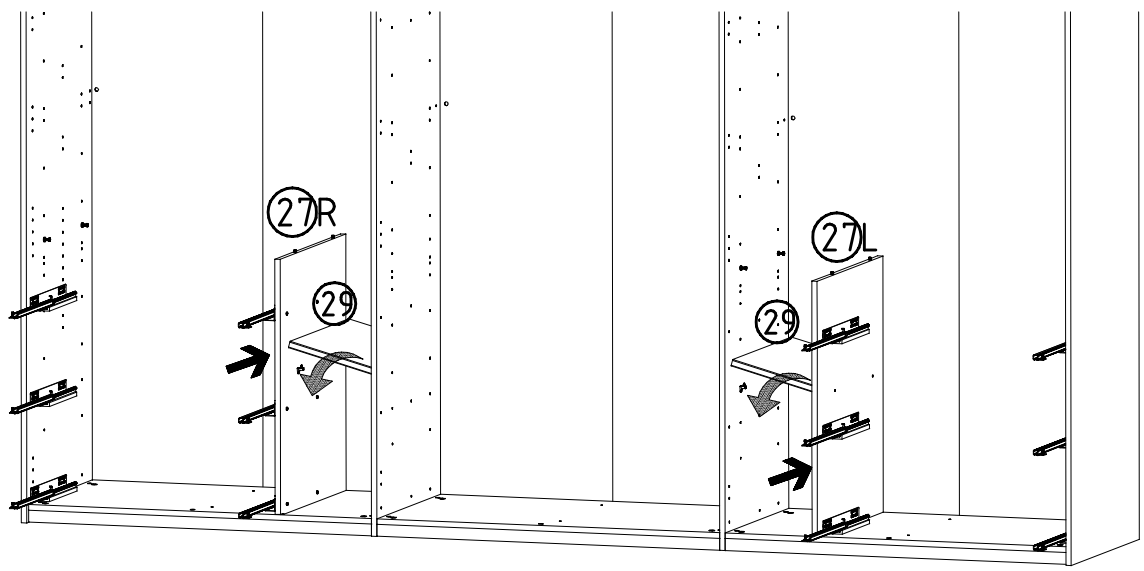

30

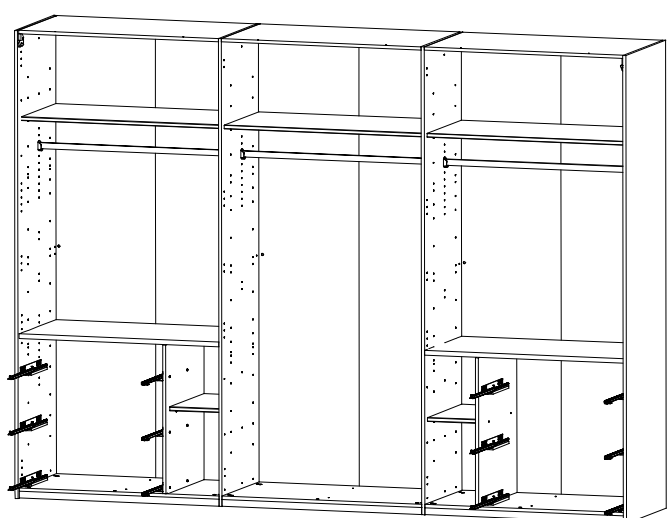
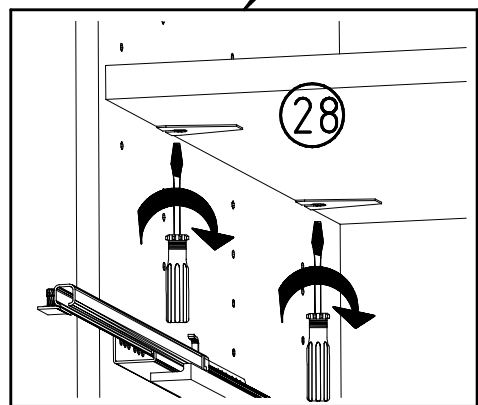
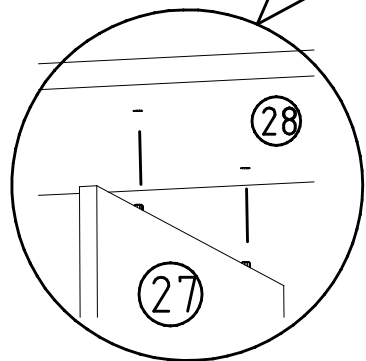
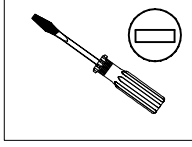
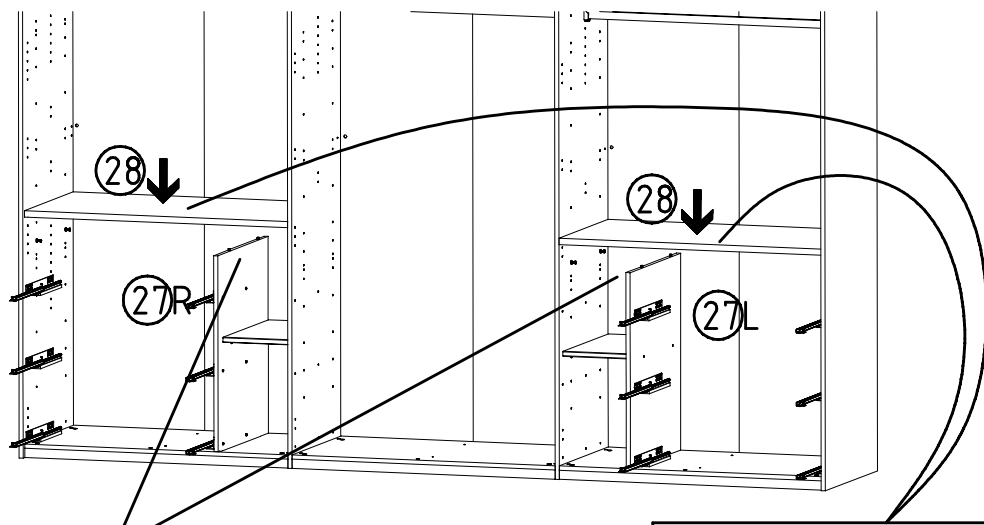

31

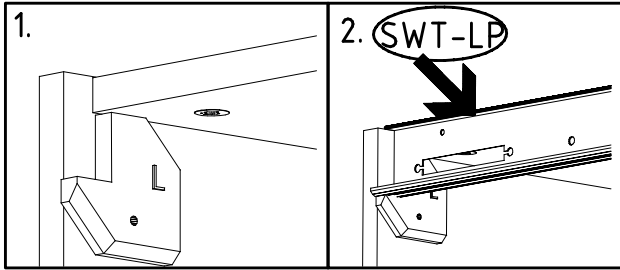

M4 x 10 mm G43 121 xxx	M4 x 13 mm GH13 121 xxx	3,5 x 35 mm G14 121 375	SWT-ST	SWT-SM5 SW-STM
------------------------------	-------------------------------	-------------------------------	--------	-------------------

SWT-LP
1453/1940/2430/2920 3trg
/3410 SY

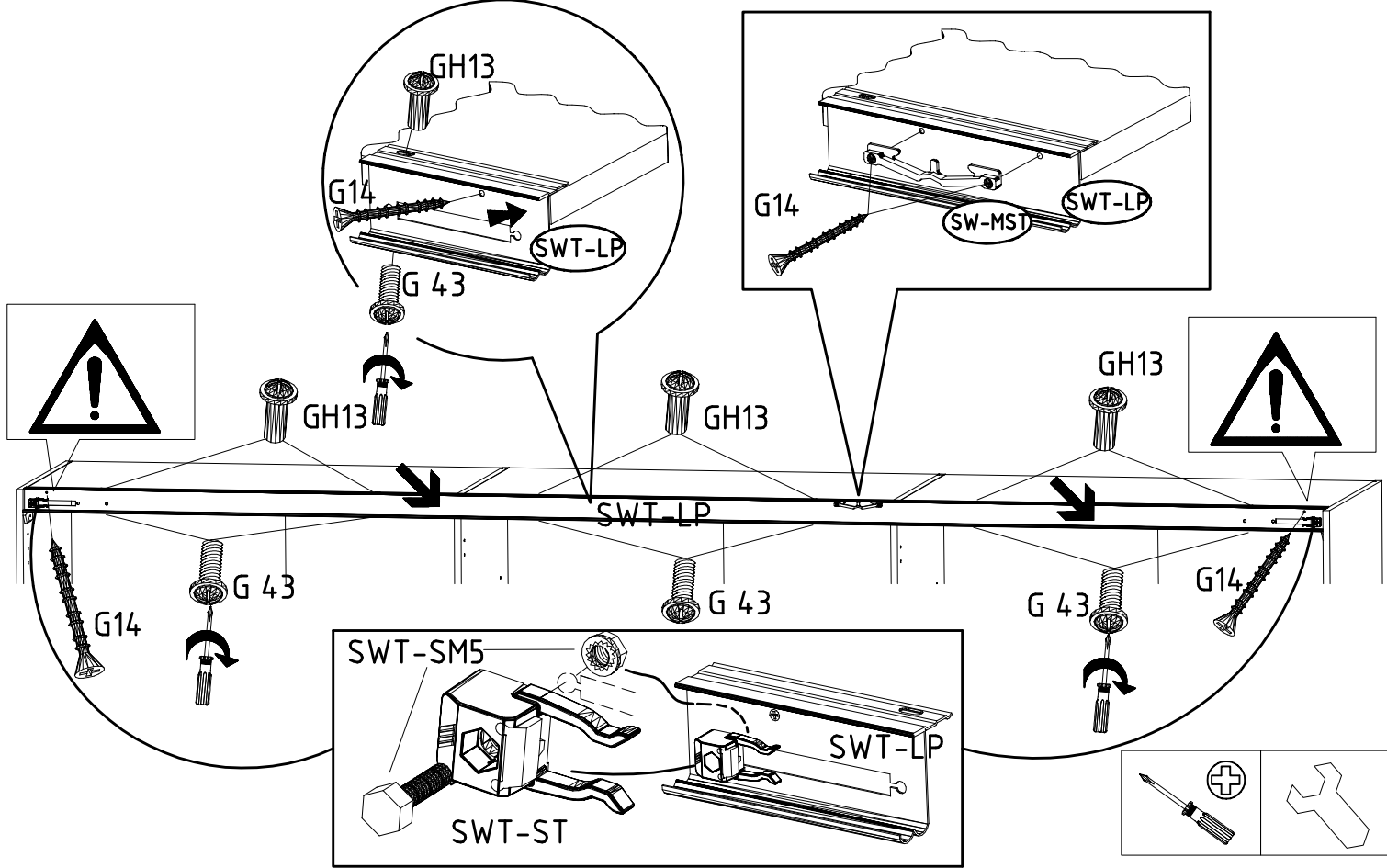

32

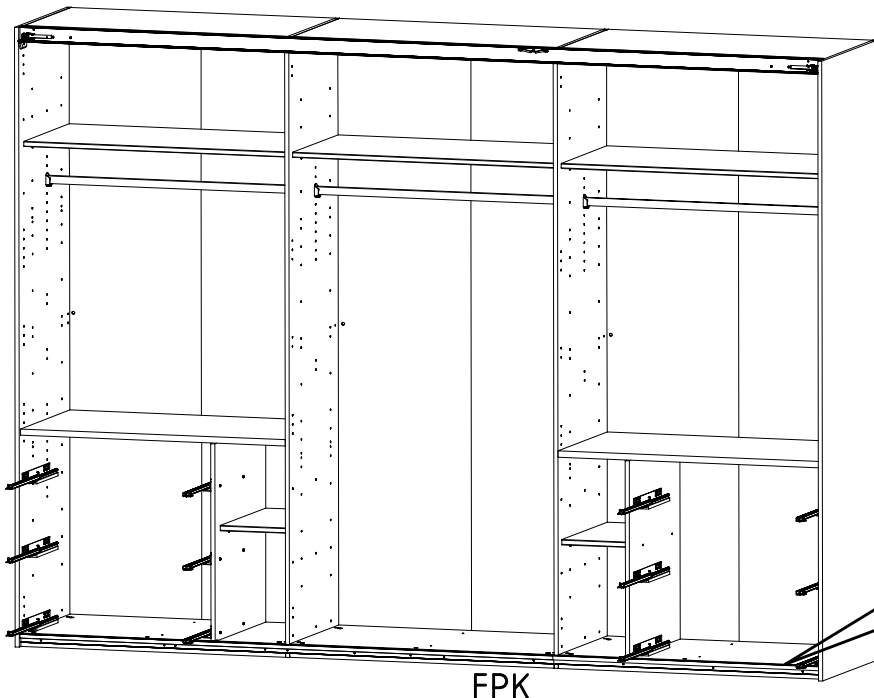

FPK
1453/1940/2430/2920/3408

3,5 x 22 mm
G24
121 004

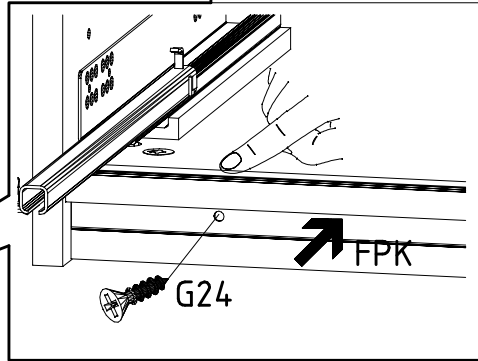

33

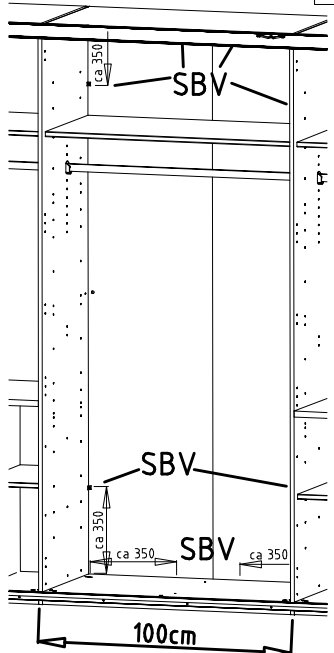
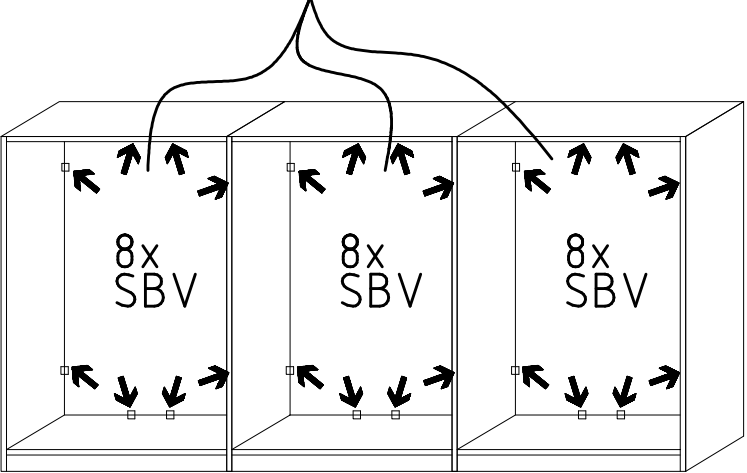
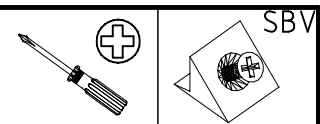
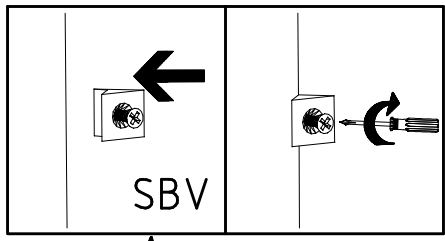

34

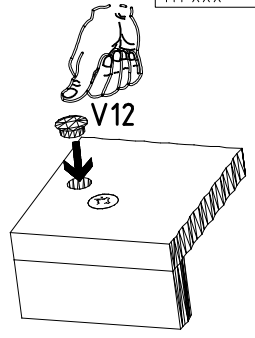
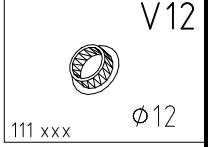
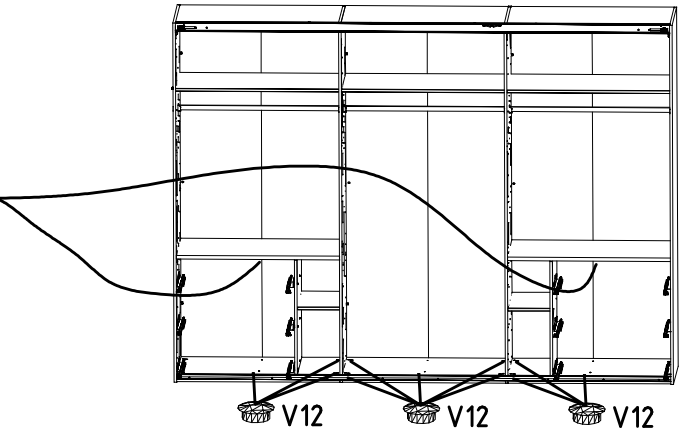
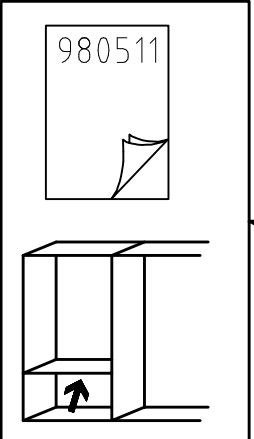

35

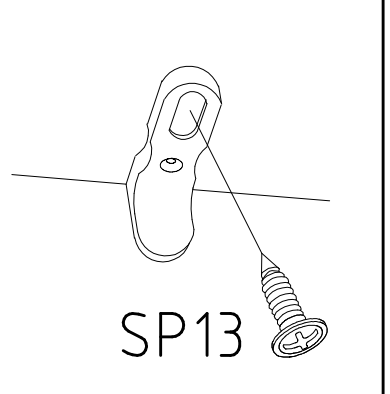
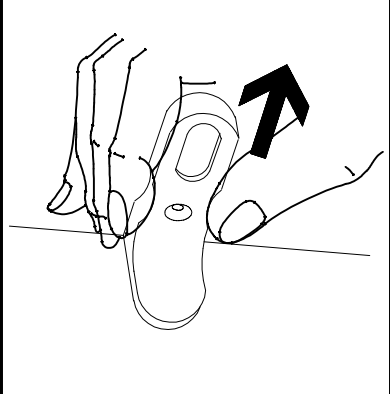
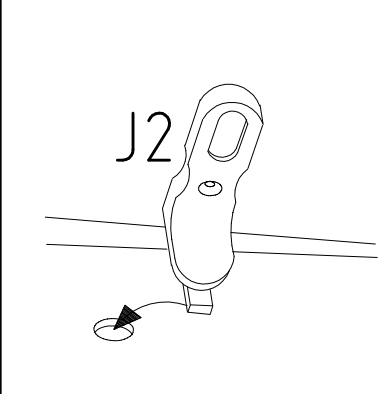
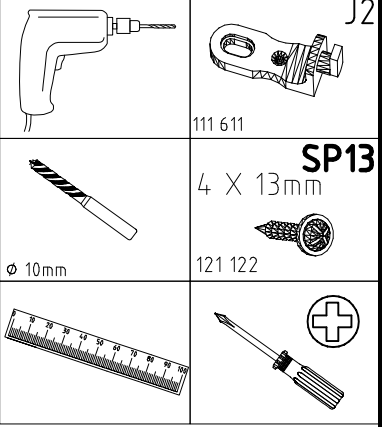
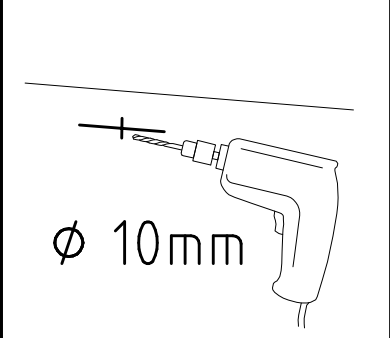
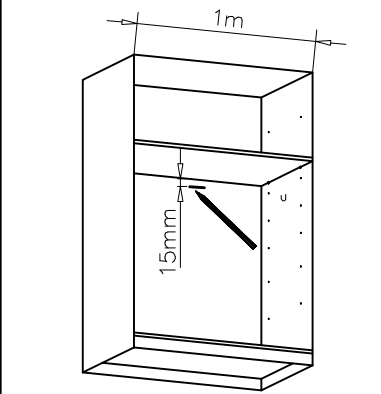

36

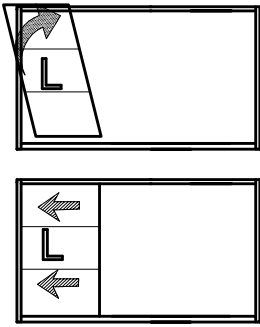

37

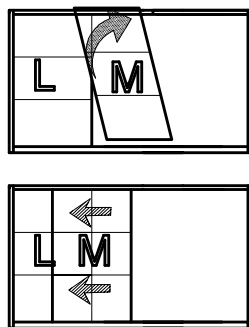

38

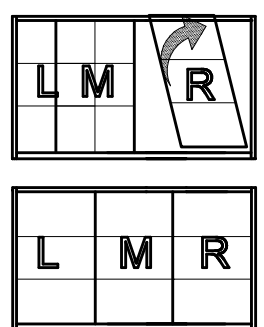

36 + 38

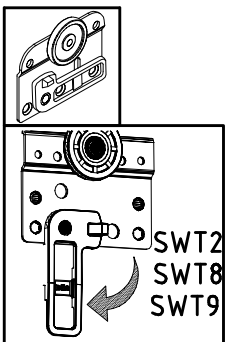
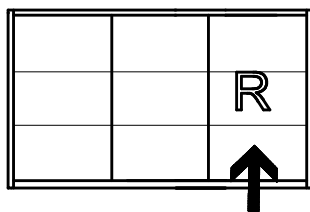
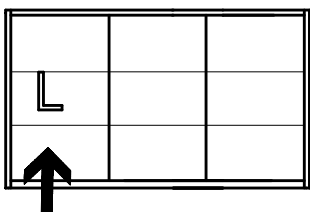

I.

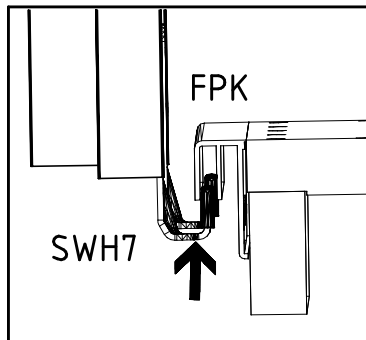

II.

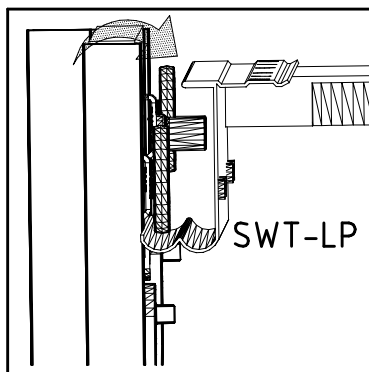

III.

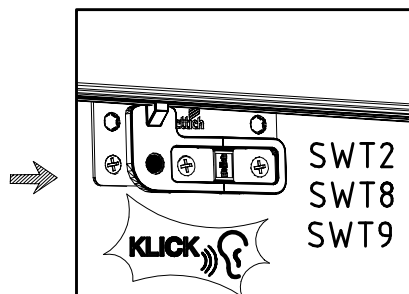
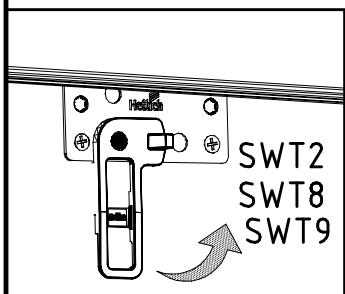

37

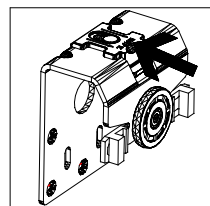
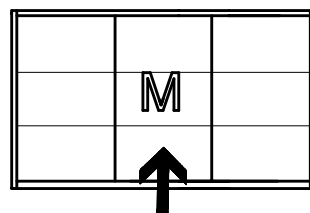

I.

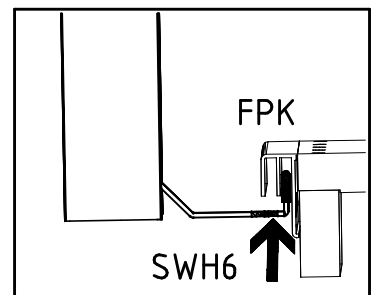

II.

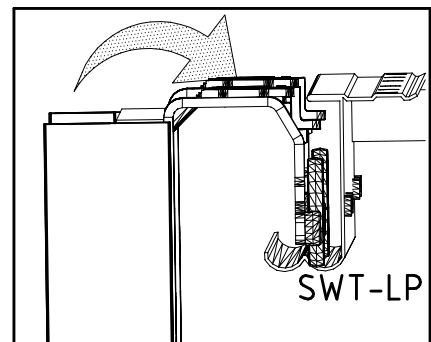

III.

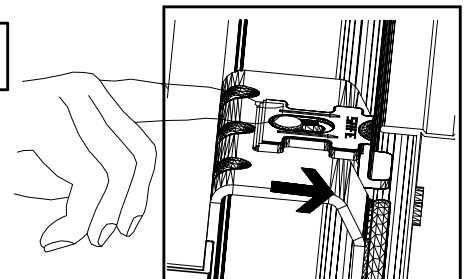

39

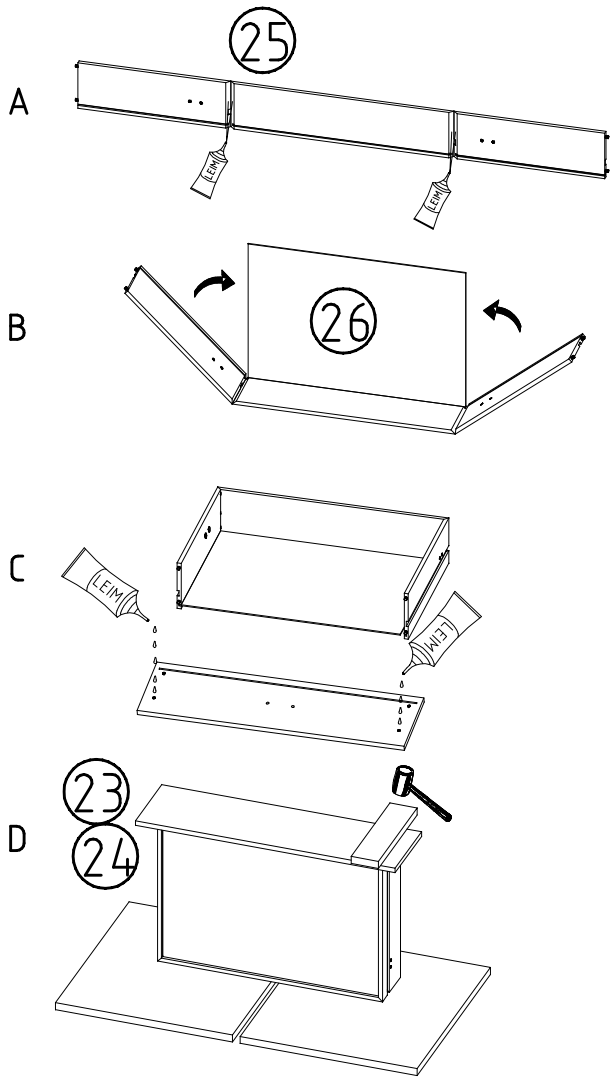
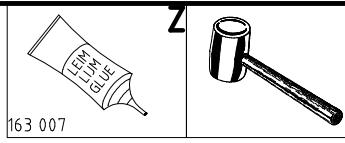

40

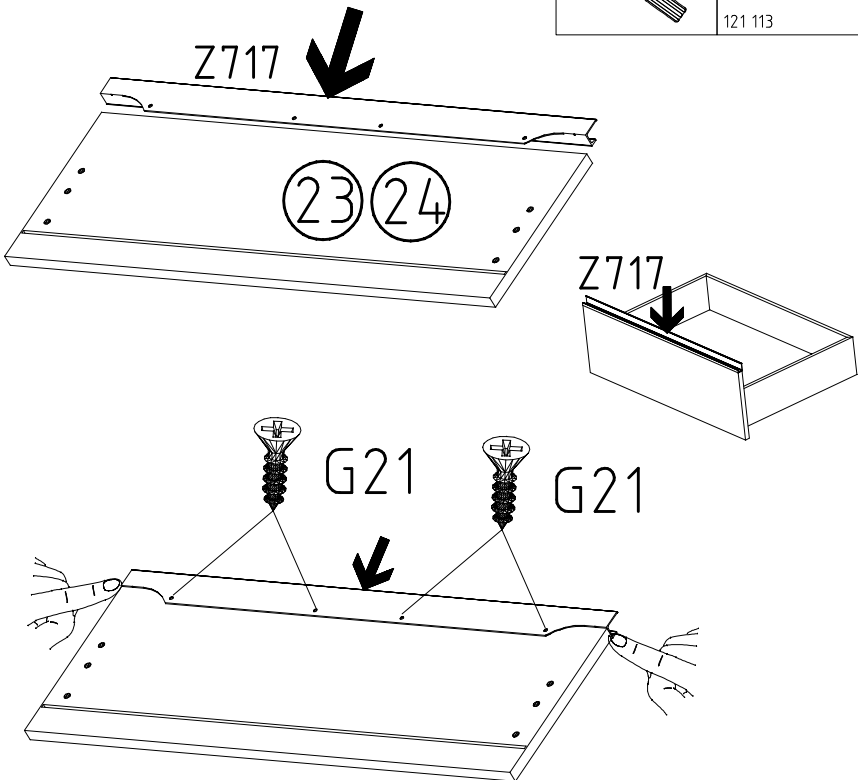
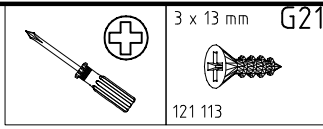

41

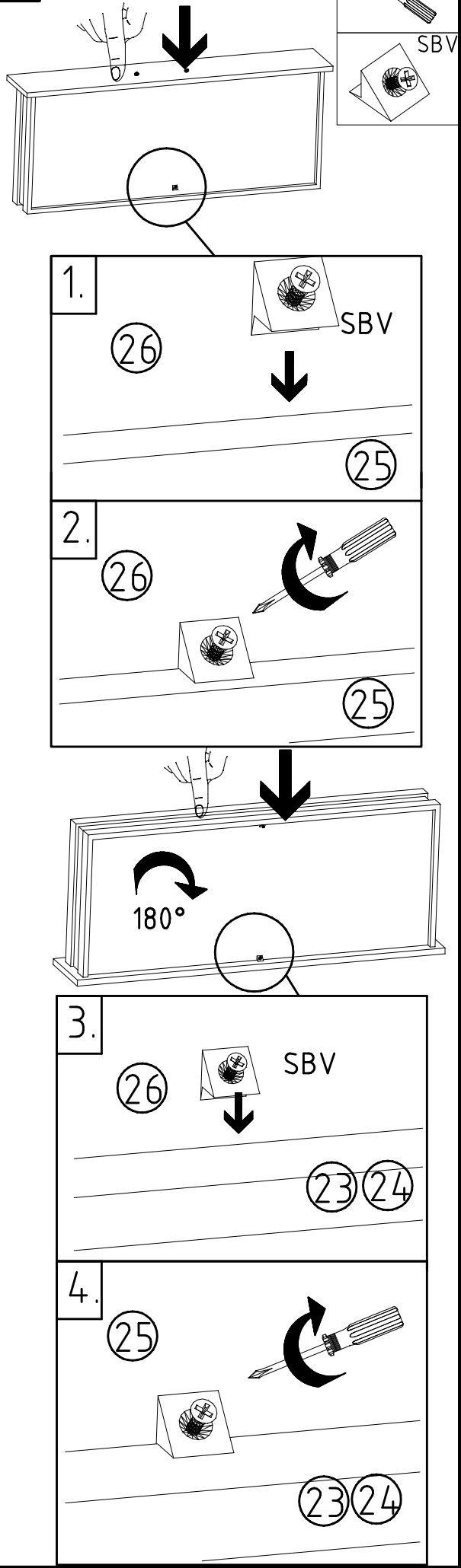
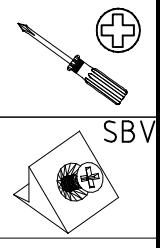

42

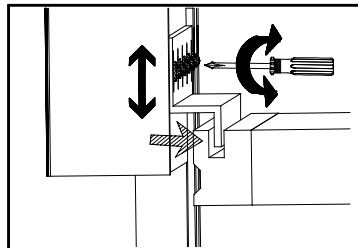
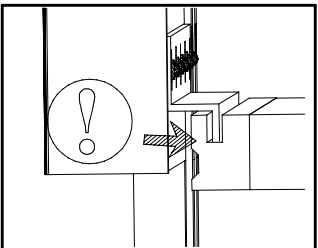
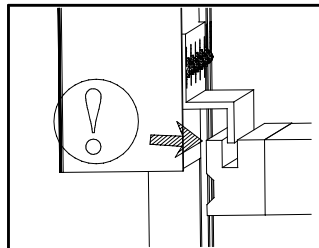
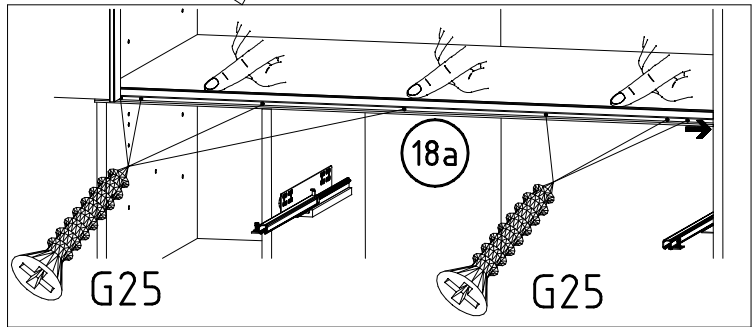
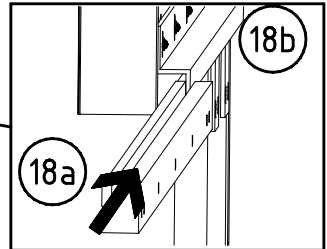
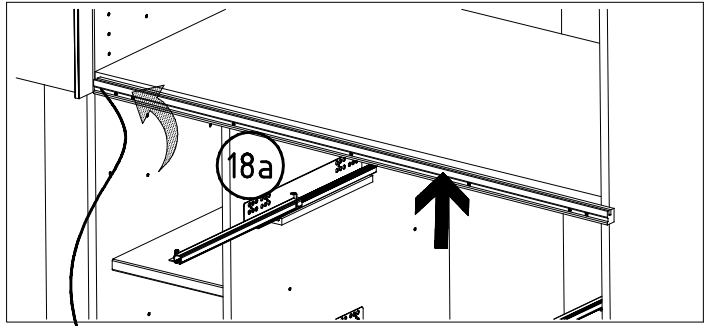
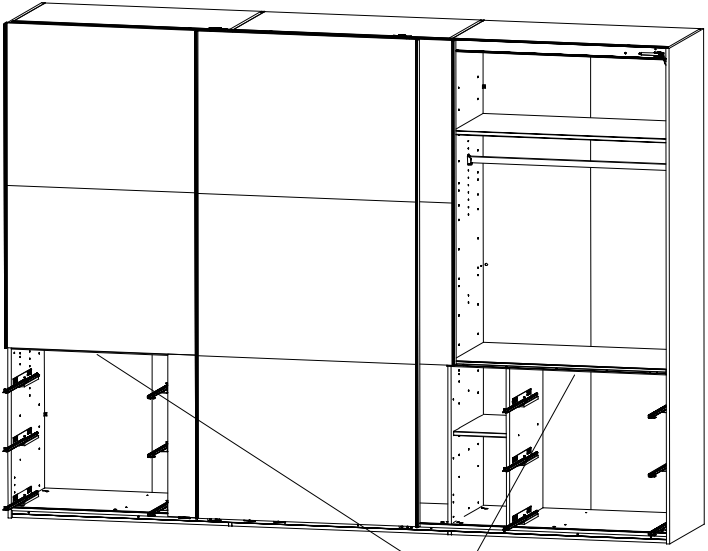
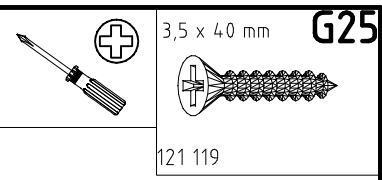

43

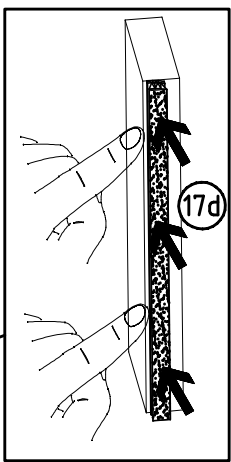
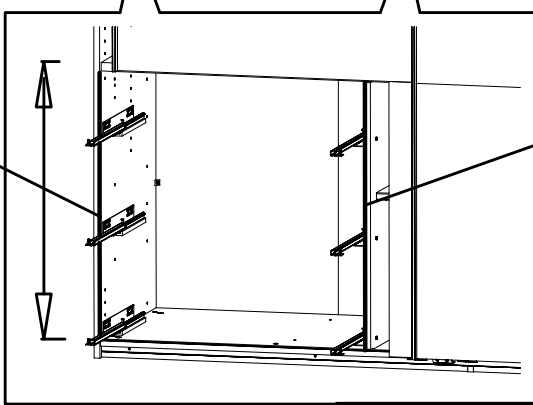
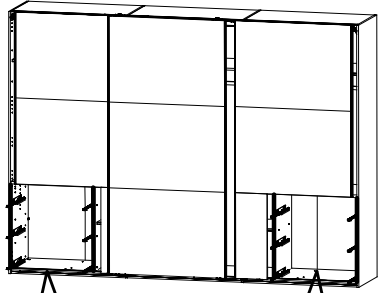
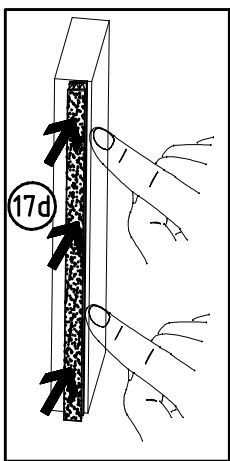
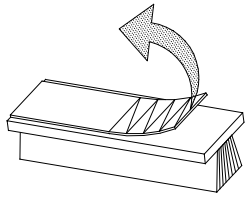
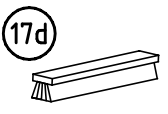

44

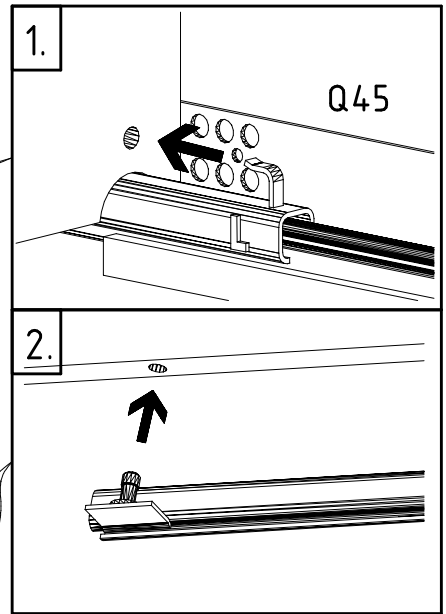
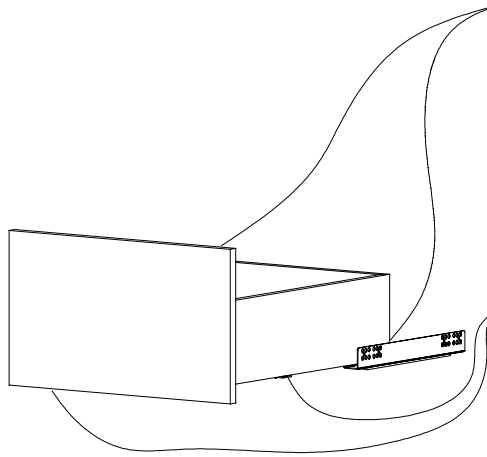
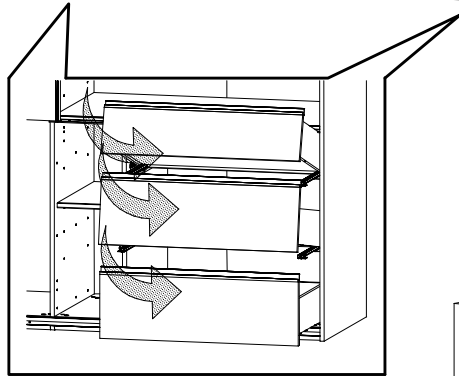
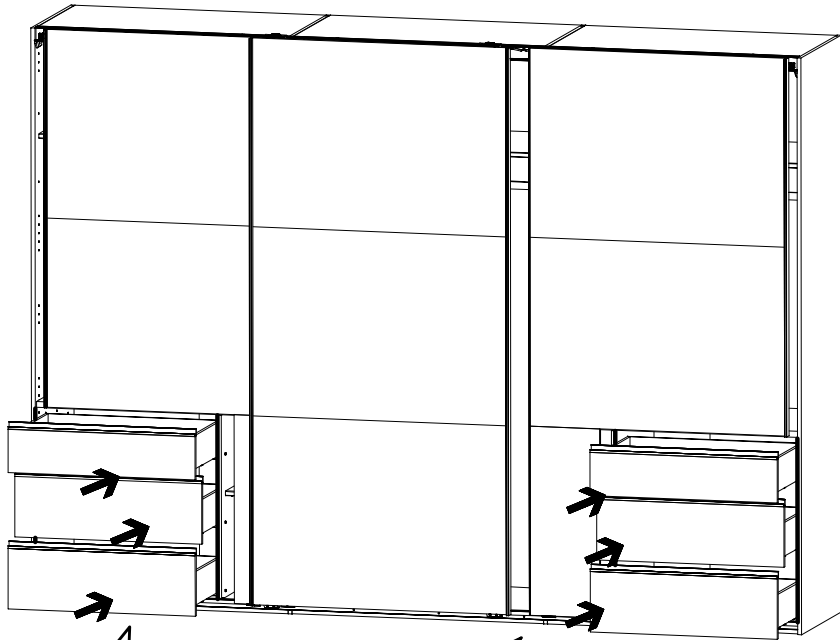

45

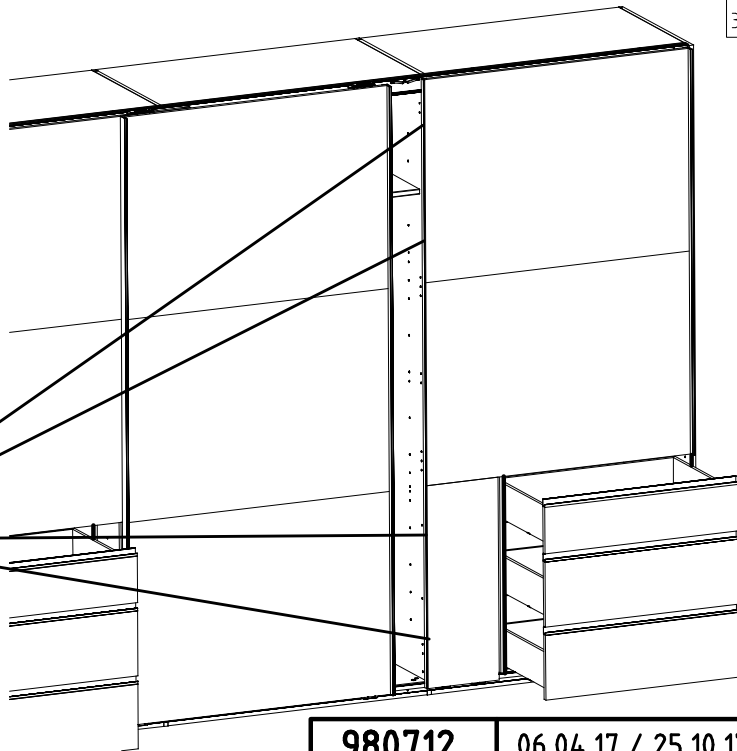
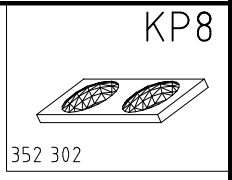
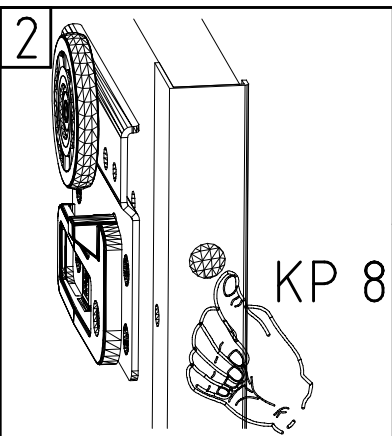
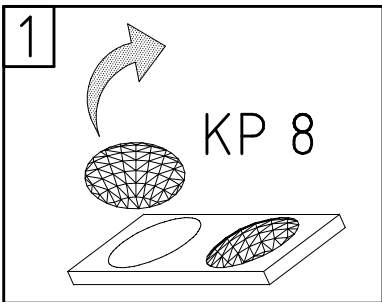

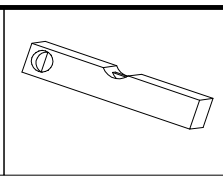
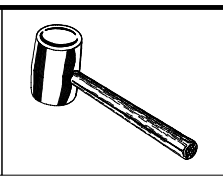
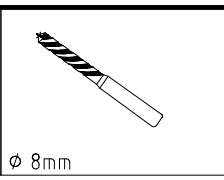
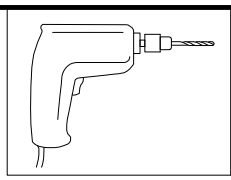

SP15
4 X 15mm
121 120

o10
111 052

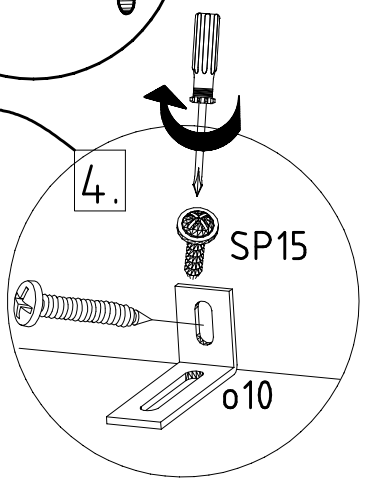
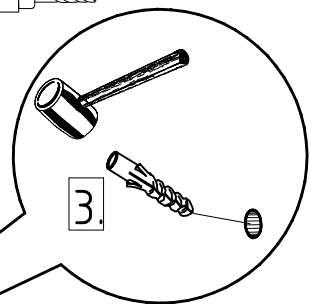
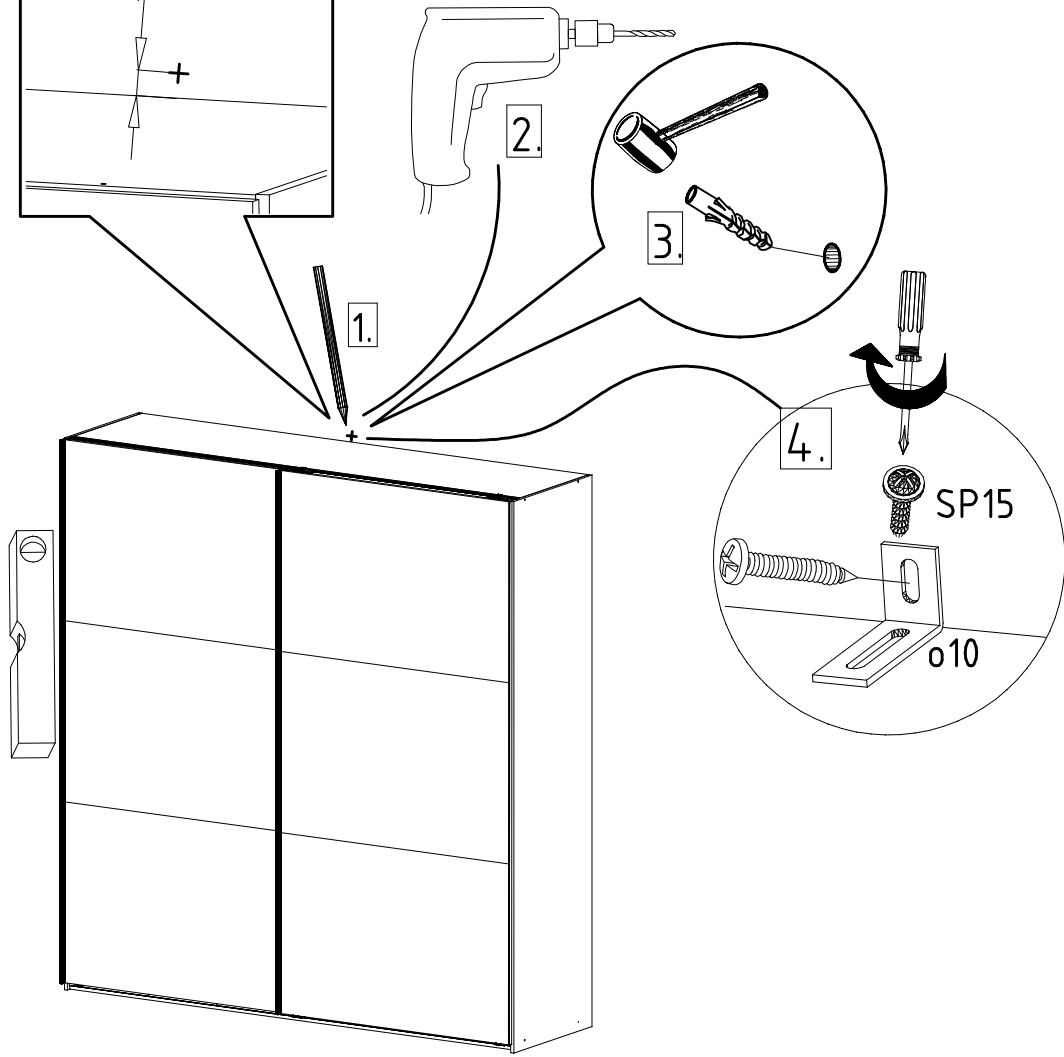
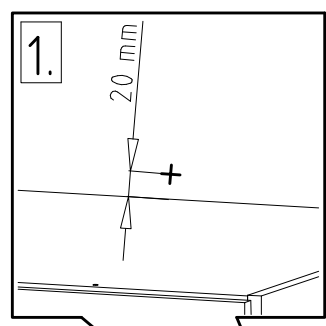
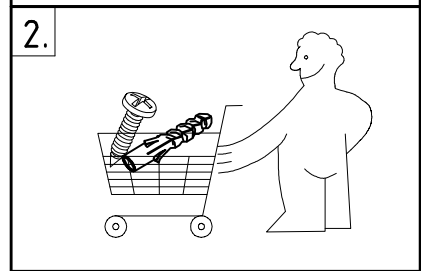
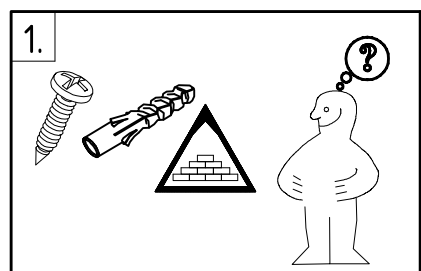

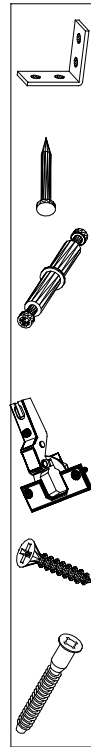
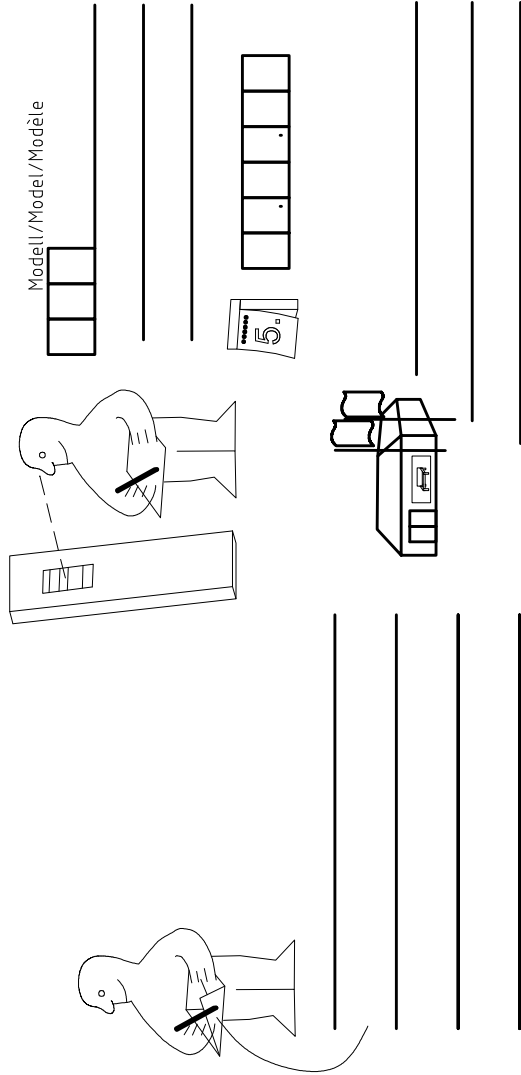
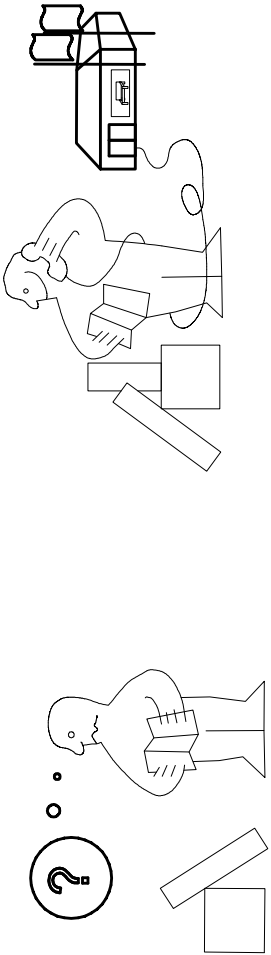
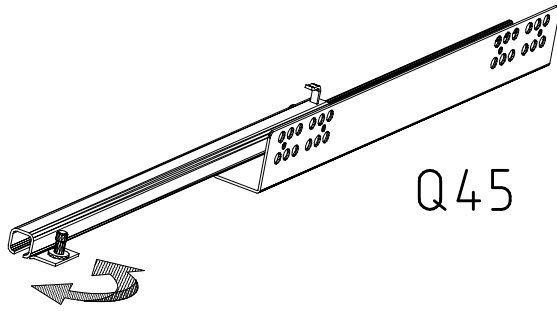
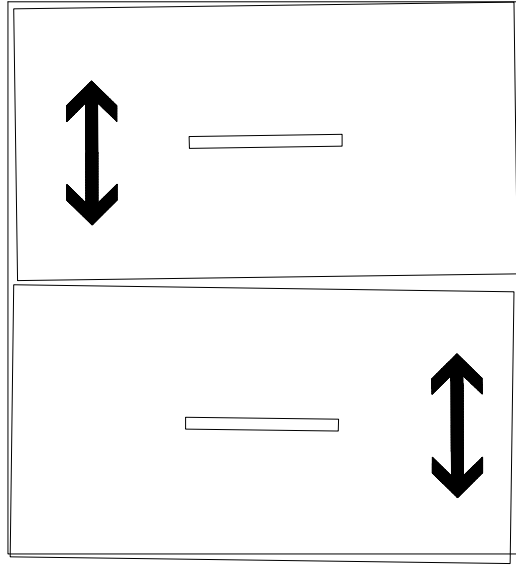

(121 370)	(G 1)	(4x)

Änderungen die dem technischen Fortschritt geschuldet sind, behalten wir uns vor!
 Bei nicht vorschriftsmäßiger und/ oder nicht fachmännischer Montage wird bei Personen-
 und/ oder Sachschäden keinerlei Haftung übernommen.

made by
 WIMEX Wohnbedarf/ Import Export Handels GmbH/ Postfach 14.07/ 49112 Georgsmarienhütte/ Germany