

980721

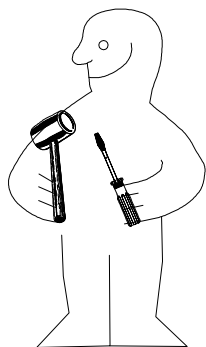

1.



2.

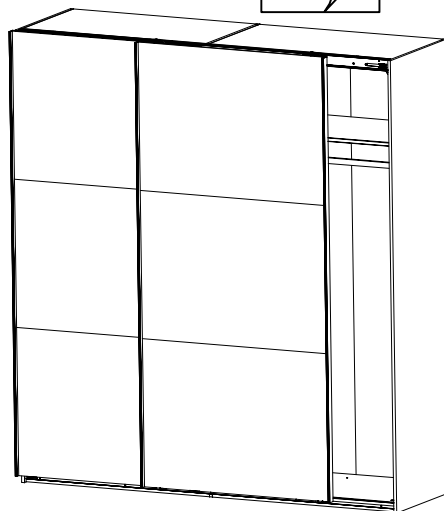
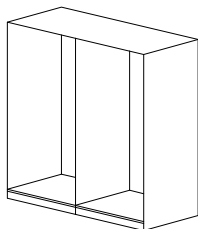



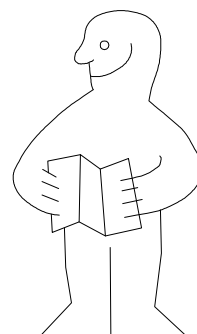
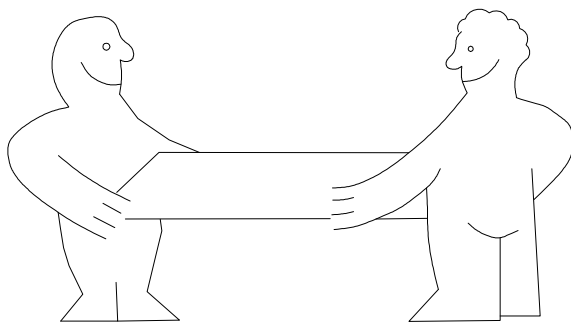
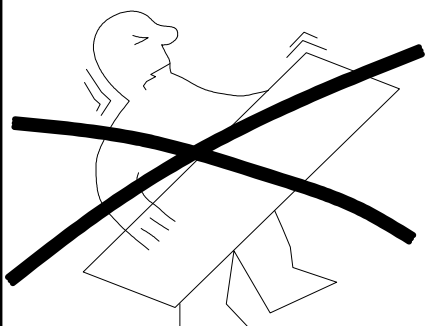

HSP 200

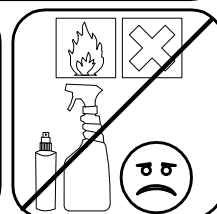
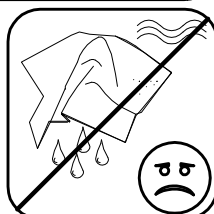
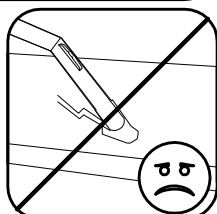
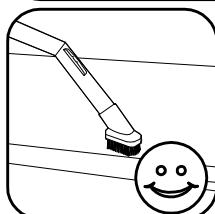
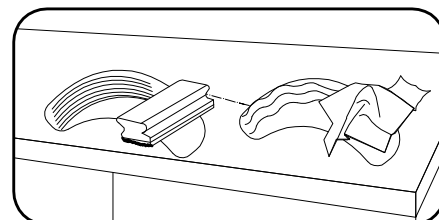
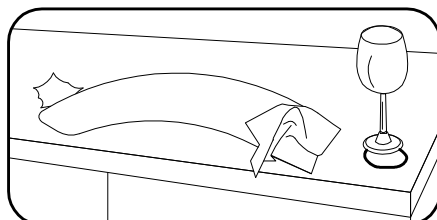
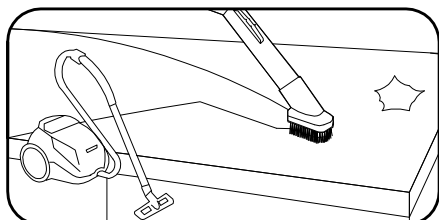
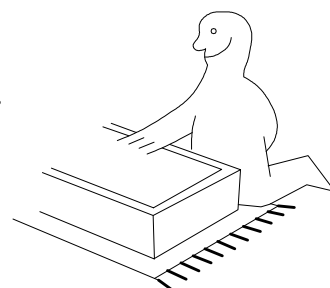
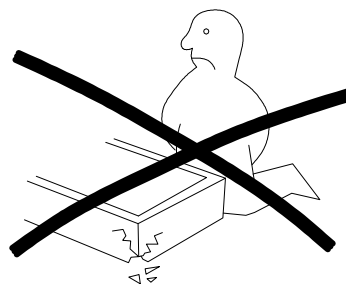
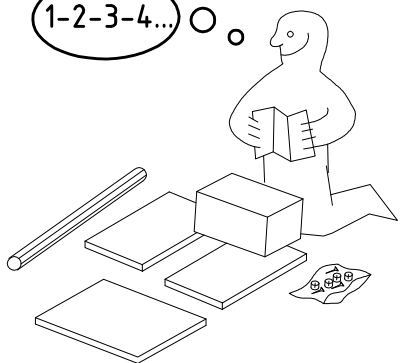

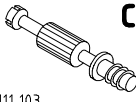



1-2-3-4... ○



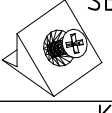

 111 xxx	A1	16x
 111 103	C	8x
	F3	4x

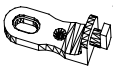
 111 xxx	S0	10x
 111 xxx ø12	V12	10x
 121 370 3,5 x 15 mm	G1	28x



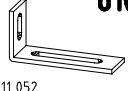

 117 002	K2	4x
	SBV	16x
 100cm 112 400	K10	2x

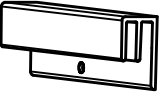

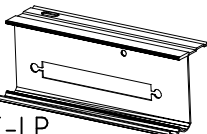
 111 611	J2	6x
 6,3 x 10,5 mm 112 055	T1	24x
 111 607	L8	8x

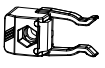
 111 052	o10	1x
 4 X 15mm 121 120	SP15	3x

1x 
FPK
1453/1940/2430/2920/3408

1x 
SWT-LP
1453/1940/2430/2920
/3410 SY

 121 xxx	SWT-ST	2x
 121 xxx M4 x 13 mm	SWT-SM5 GH13	2x
 121 xxx M4 x 10 mm	G43	4x
 121 xxx 3,5 x 35 mm	G14	4x
 121 375	G14	2x

 121 004	SWH-SKL	1x
 121 004 3,5 x 22 mm	SWH-SKR	1x
	G24	7x

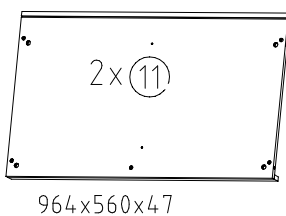
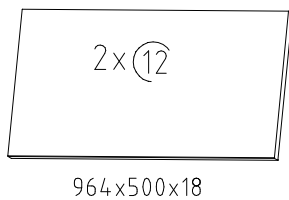
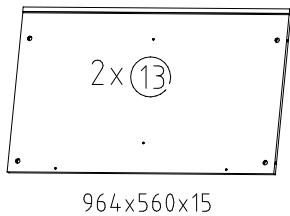
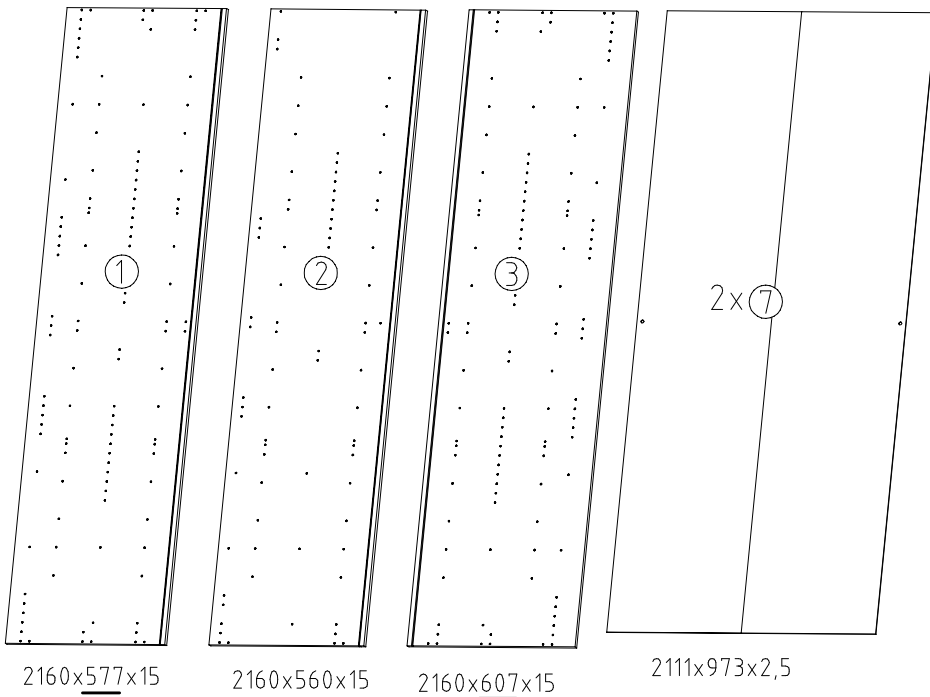
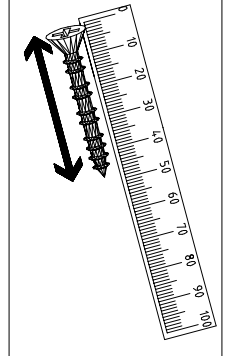
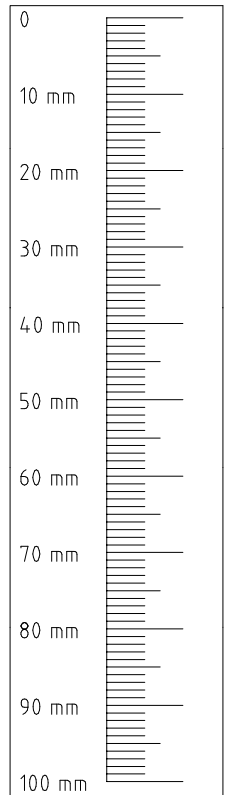
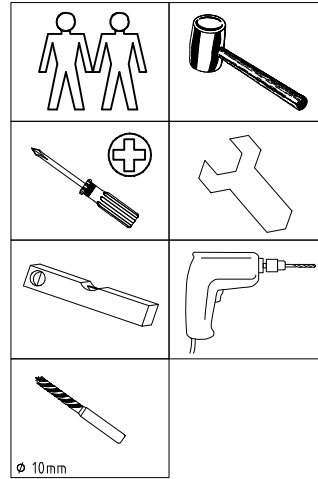

1

3,5 x 15 mm

G1

S0

A1

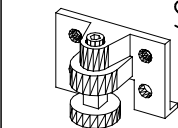
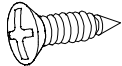

121 370

111 xxx

111 xxx

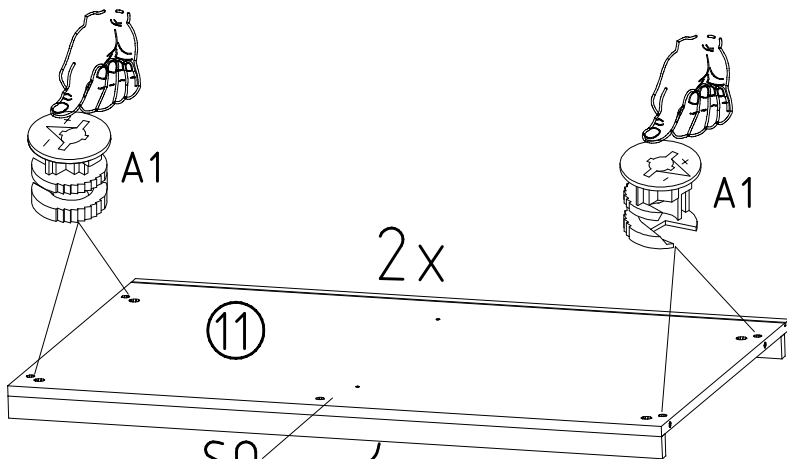

2x

11

S0

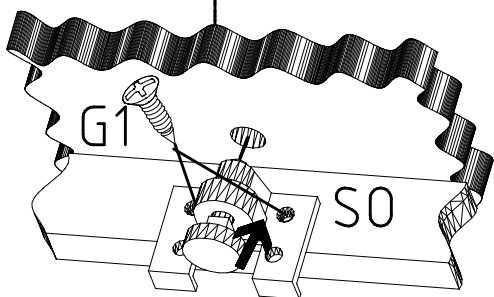

G1

S0

2

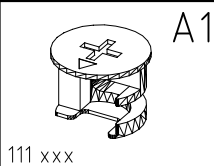

A1

111 xxx

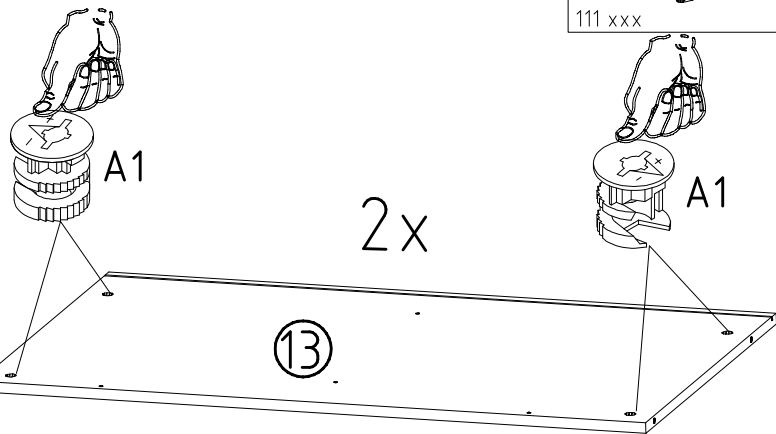

2x

13

3

F3

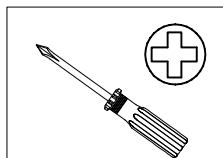

6,3 x 10,5 mm T1

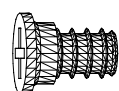

112 055

3,5 x 15 mm

G1

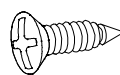

121 370

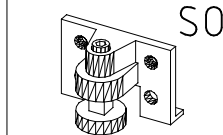

S0

111 xxx

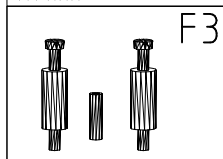

F3

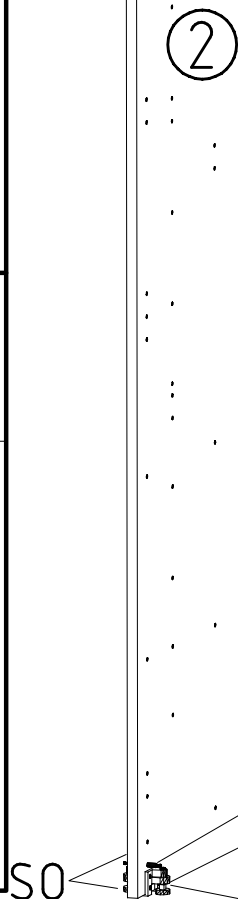

2

F3

S0

S0

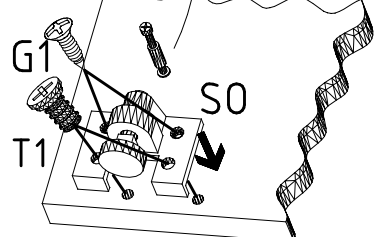
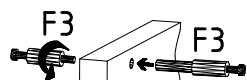
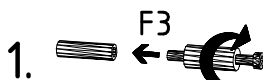

G1

T1

S0

4

SWH-SKL

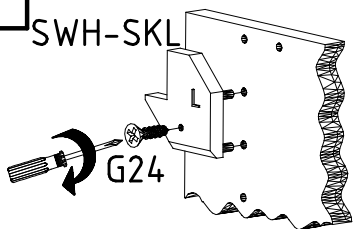

SWH-SKR

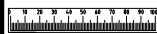
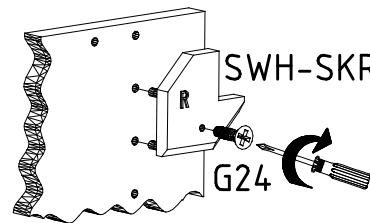

577

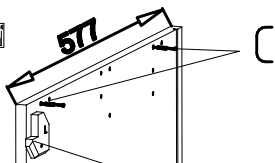

SWH-SKL
+G24



607

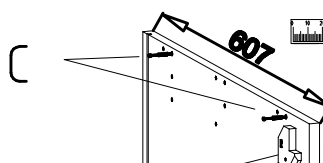
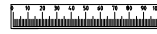

SWH-SKR
+G24

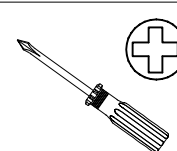

SWH-SKL

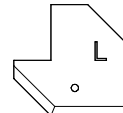

SWH-SKR

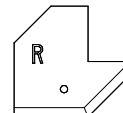

3,5 x 22 mm

G24

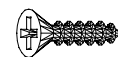

121 004

6,3 x 10,5 mm

T1

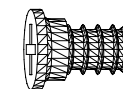

112 055

3,5 x 15 mm

G1

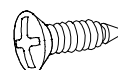

121 370

C

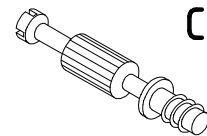

111 103

SO

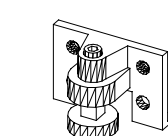

111 xxx

1

3

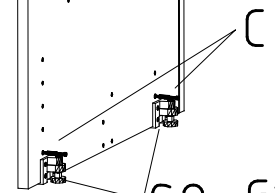

SO

G1

SO

T1

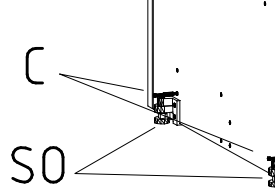
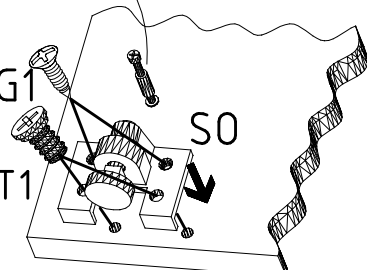

SO

5

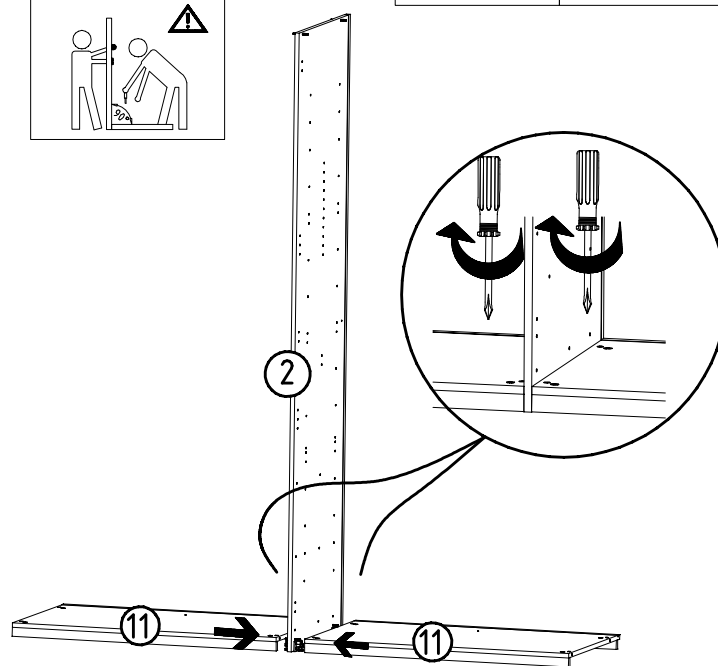
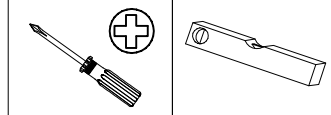

6

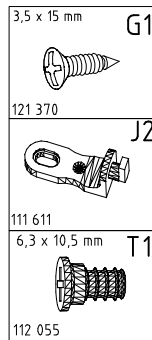
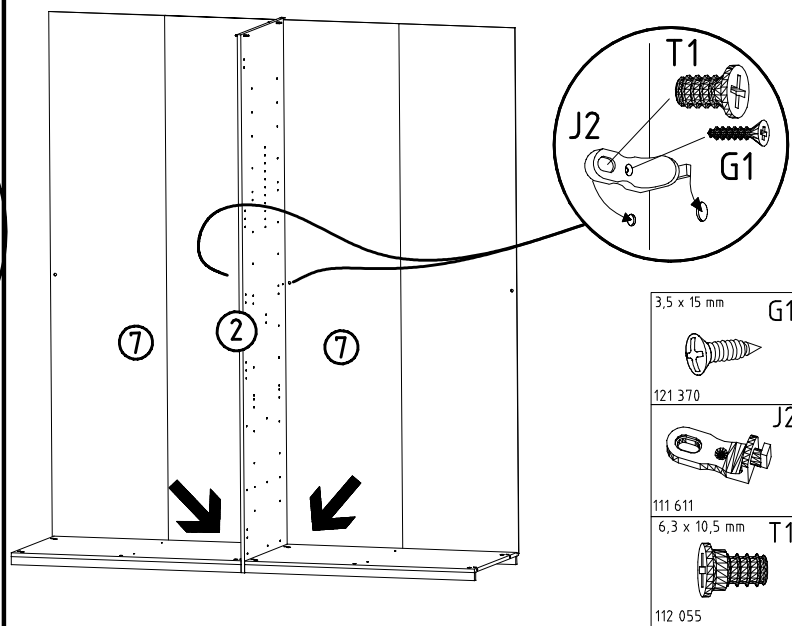
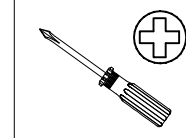

7

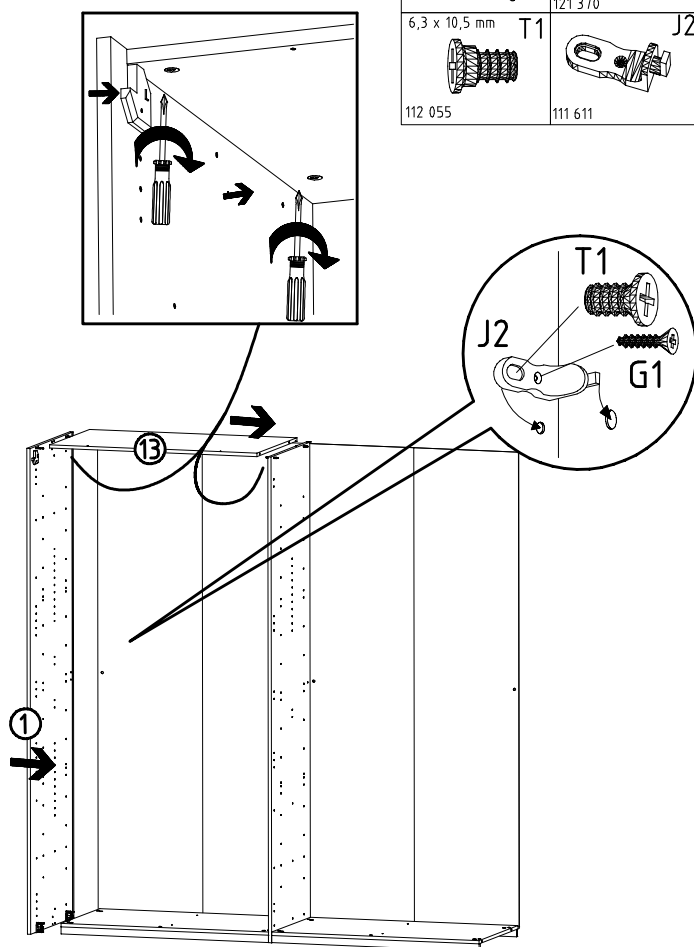
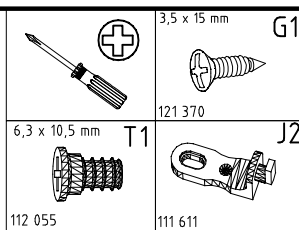

8

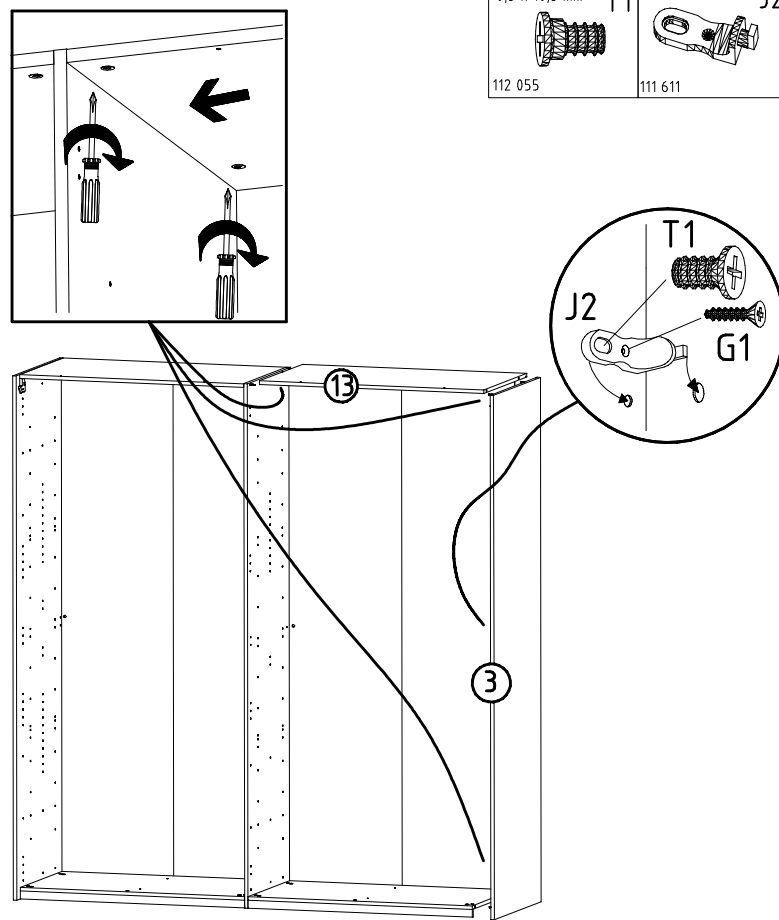
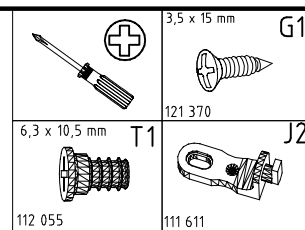

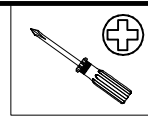

111 607

L8



K2

117 002

3,5 x 15 mm

G1



121 370

K10

100cm

112 400

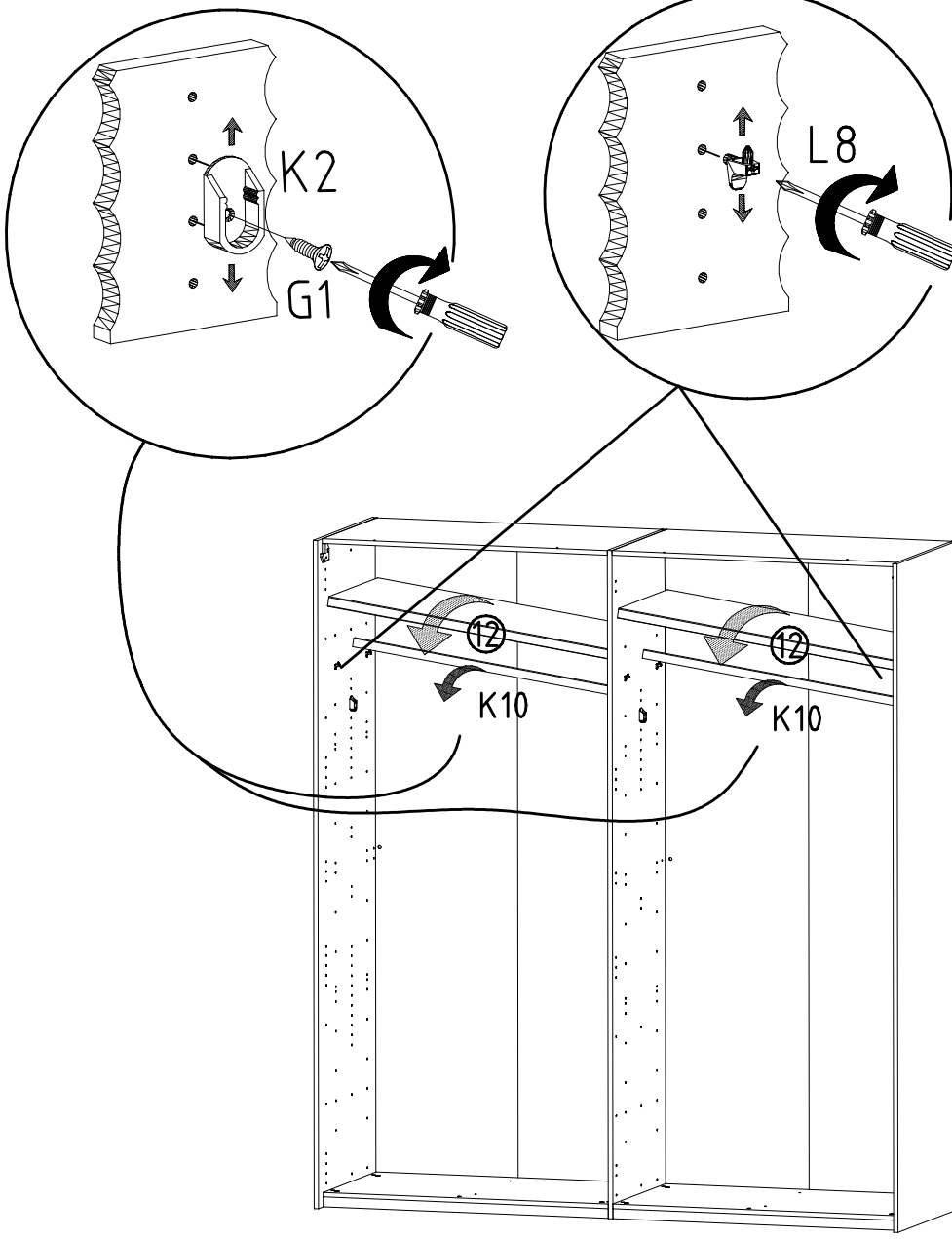

10

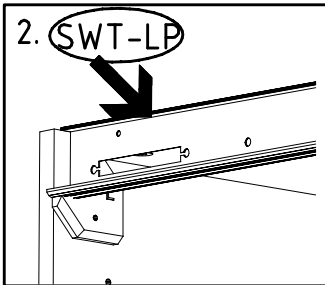
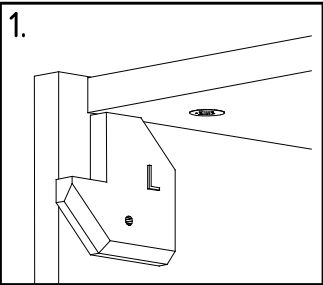

- M4 x 10 mm G43 121 xxx
- M4 x 13 mm GH13 121 xxx
- 3,5 x 35 mm G14 121 375
- SWT-ST
- SWT-LP 1453/1940/2430/2920 /3410 SY
- SWT-SM5

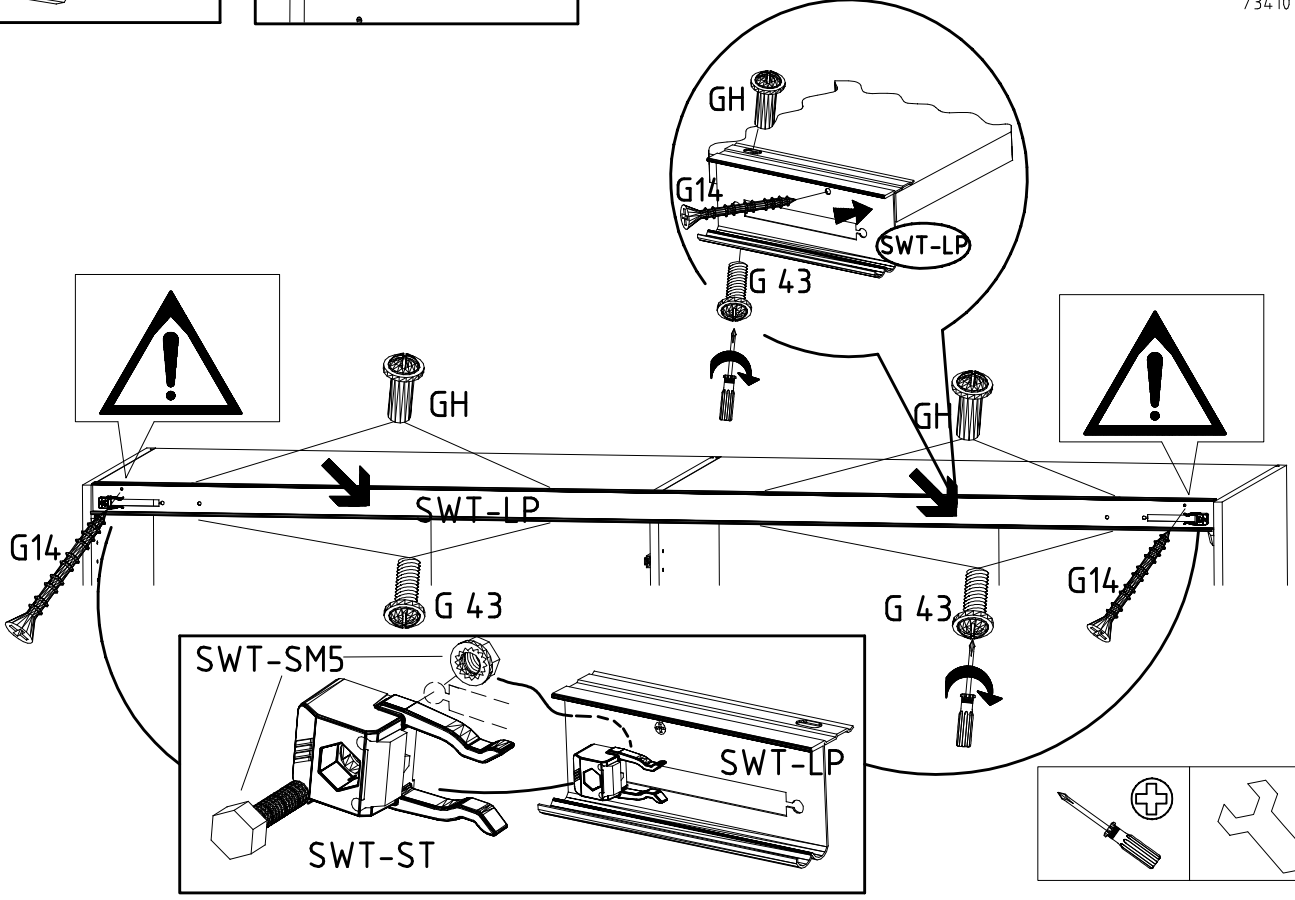

11

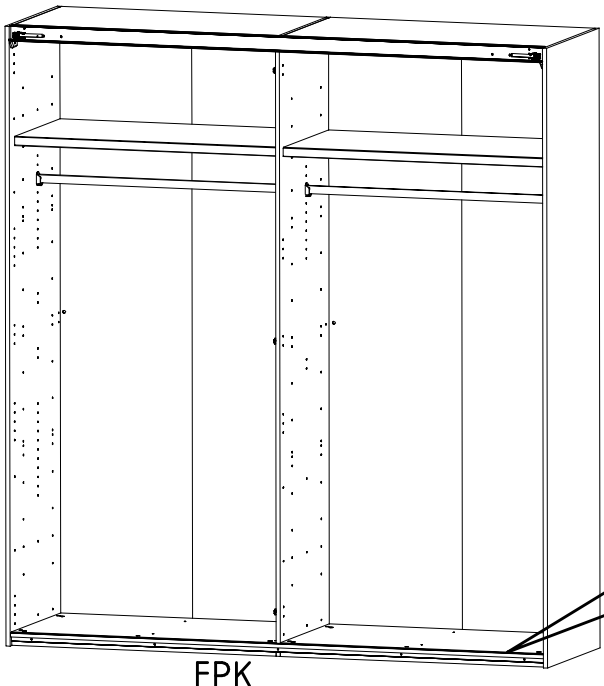

- FPK 1453/1940/2430/2920/3408
- 3,5 x 22 mm G24 121 004

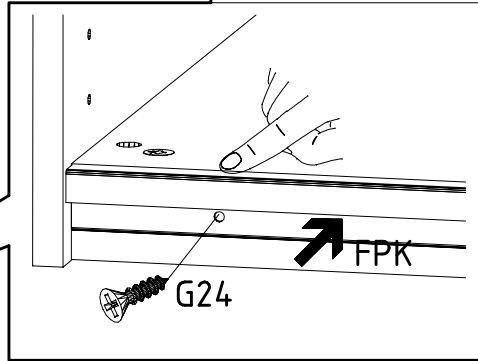

12

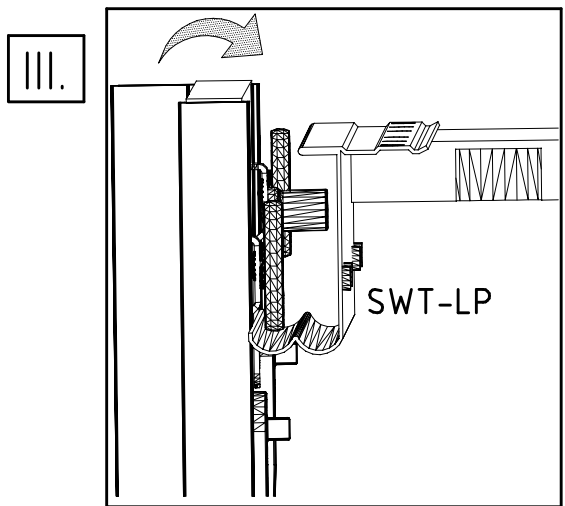
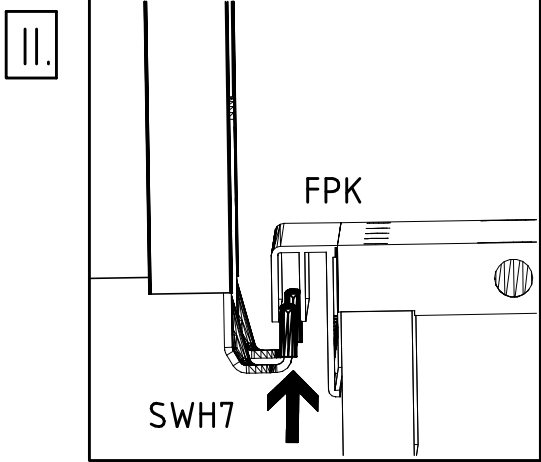
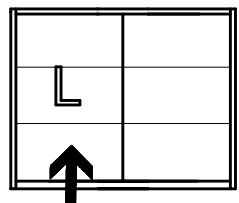
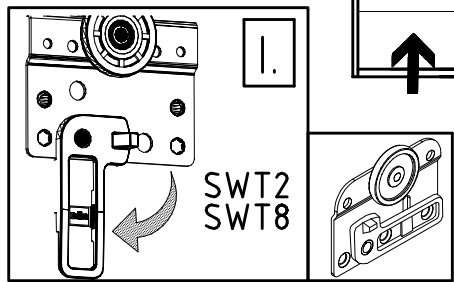

IV.

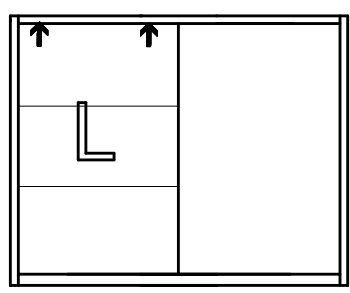
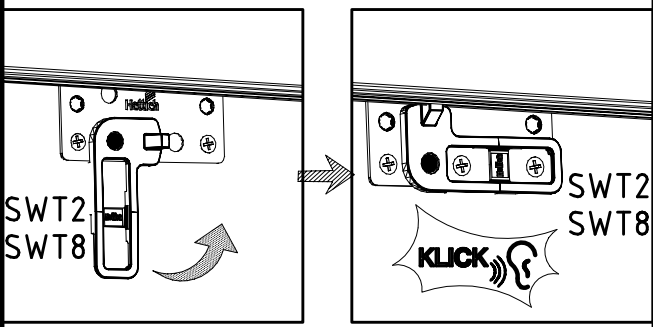

13

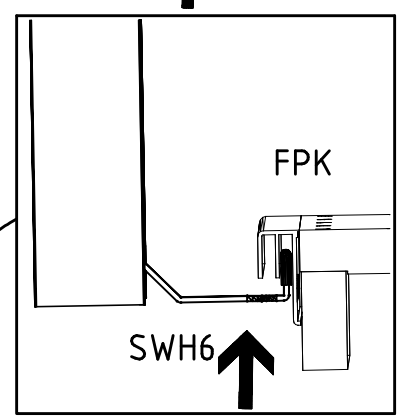
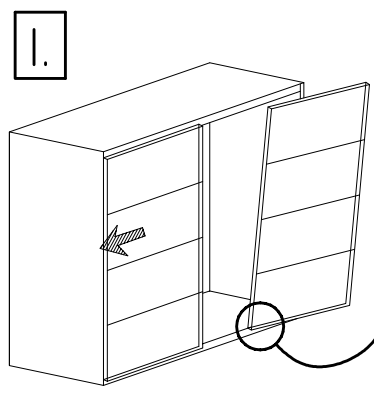
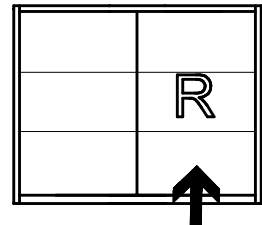
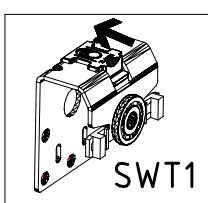

II.

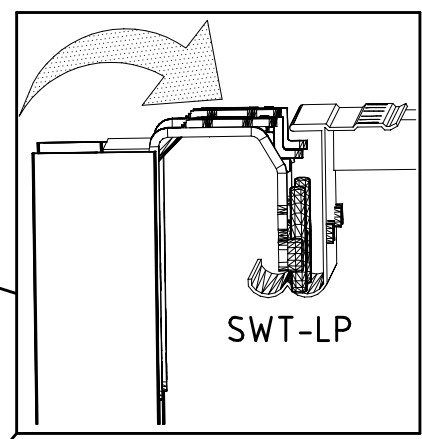
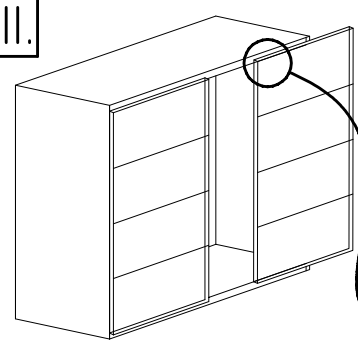

III.

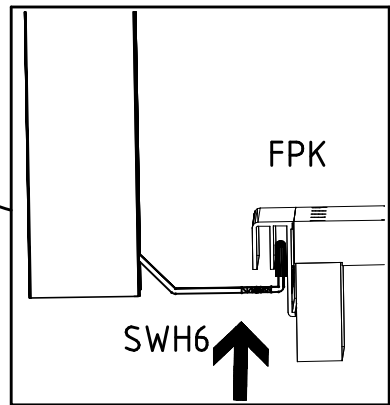
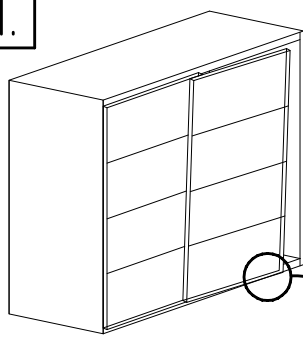

IV.

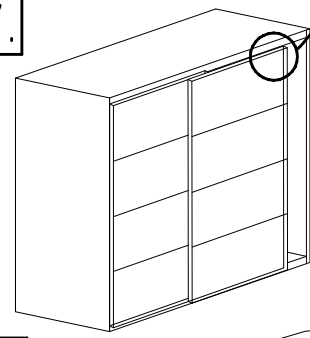

V.

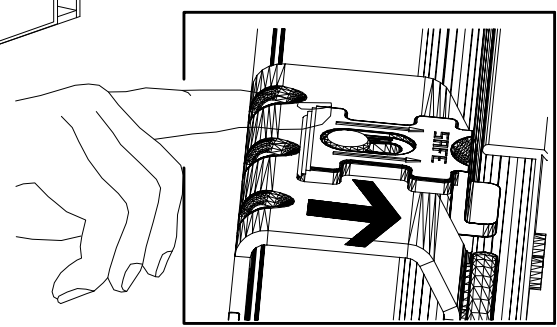
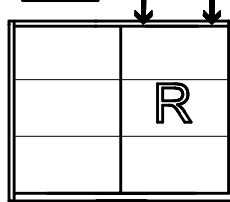

14

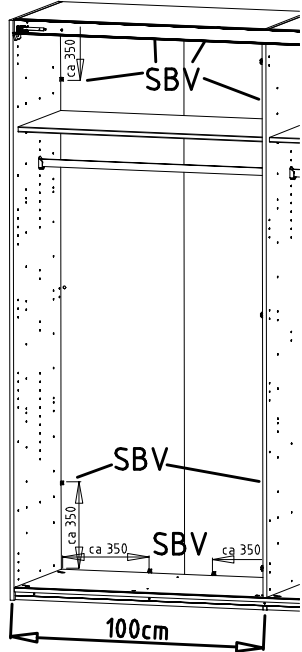
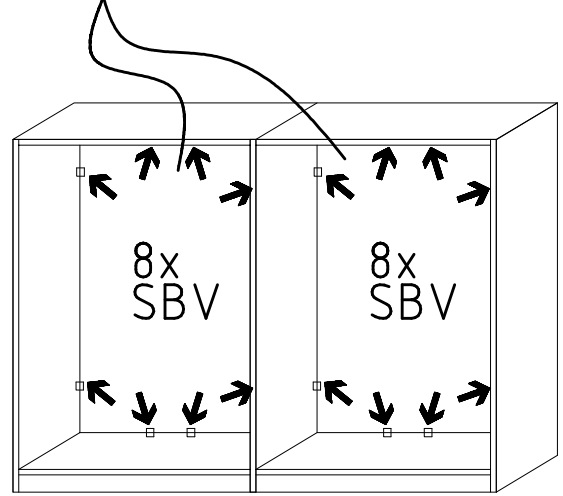
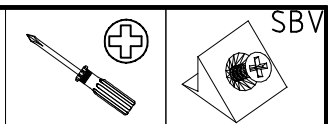
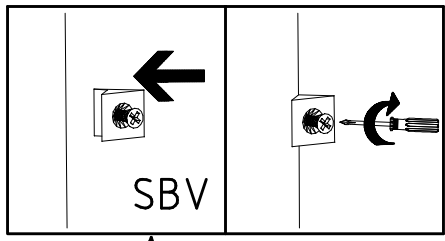

15

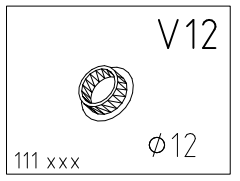
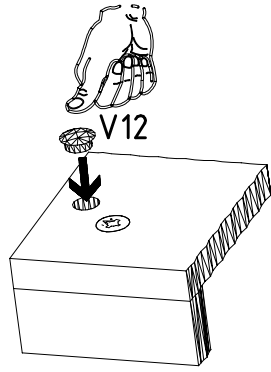
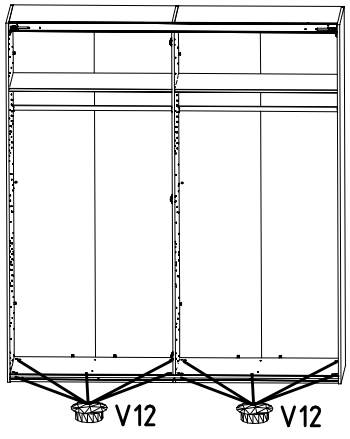

16

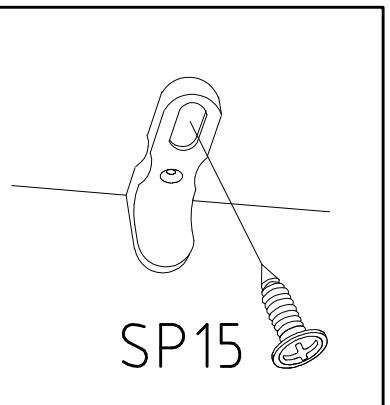
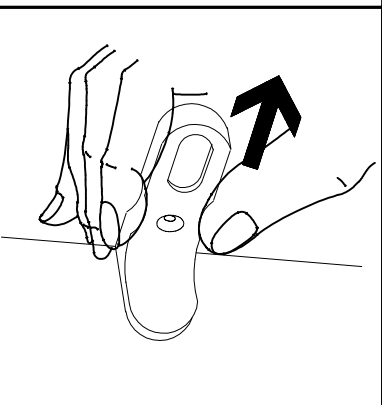
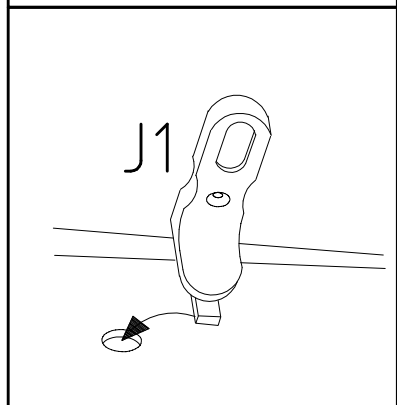
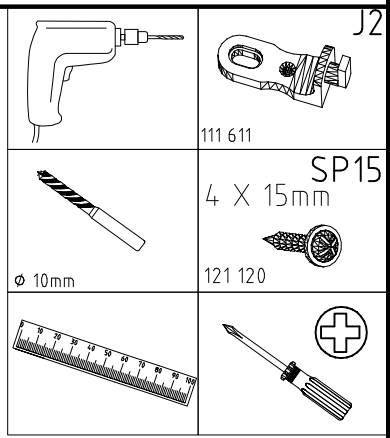
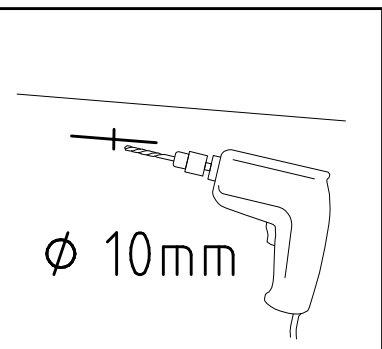
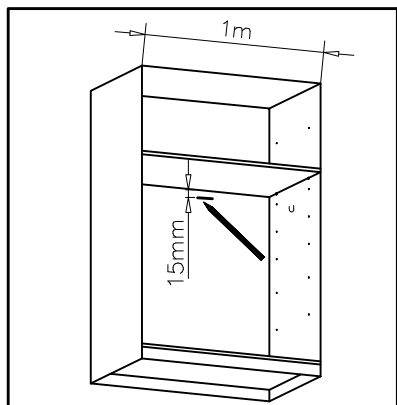

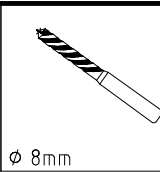
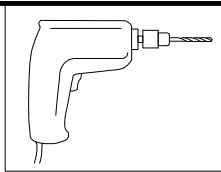

ø 8mm

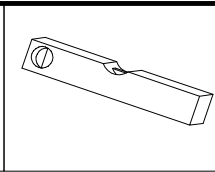
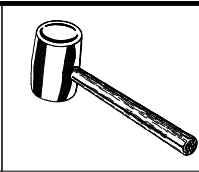

SP15
4 X 15mm
121 120

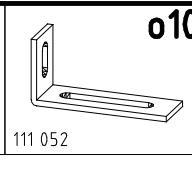

o10

111 052

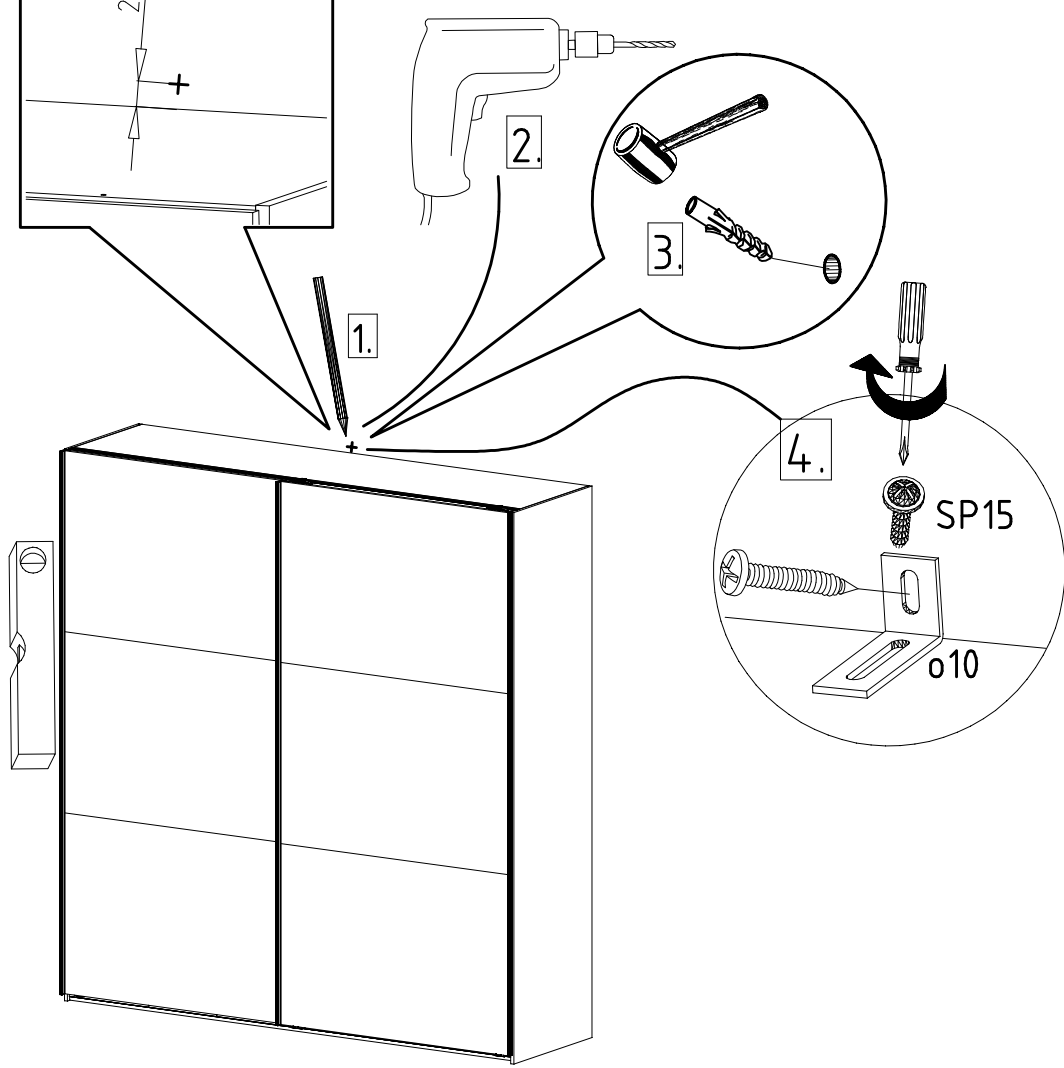
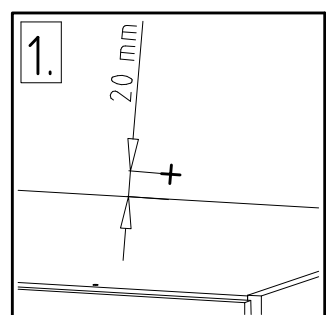
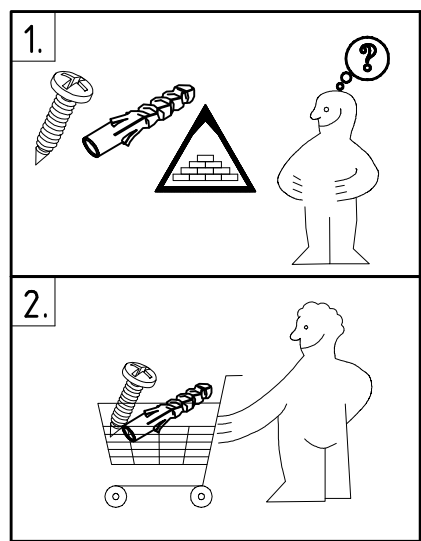

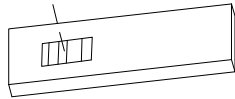
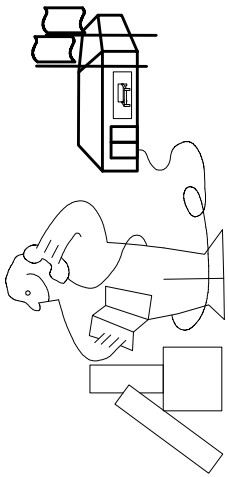
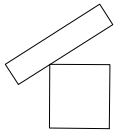
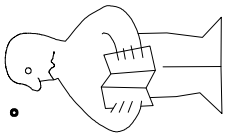

Modell/Model/Modèle



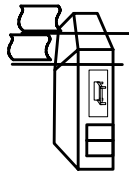

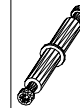
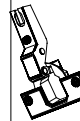
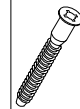

{121 370}

{ G 1 }

{4x}

Änderungen die dem technischen Fortschritt geschuldet sind, behalten wir uns vor !

Bei nicht vorschriftsmäßiger und/ oder nicht fachmännischer Montage wird bei Personen- und/ oder Sachschäden keinerlei Haftung übernommen.

WIMEX Wohnbedarf/ Import Export Handels GmbH/ Postfach 1407/ 49112 Georgsmarienhütte/ Germany
Tel.:(+49) 054-01 8598 16/17 Fax.:(+49) 054-01 8598 33 Mail: service_H@wimex-online.com

104P-Nr. / 104P-No. 150X-Nr. / 150X-No. Auftrag/Order-No. / No. de Commande

23203 **30110XY** 104

Kunde MAX MUSTERMANN
Customer
Client

Kommission / your order reference / votre reference

3377 MINDEN

Dekor / Decor Decor / Modell / Modele

F99 **SAMPLE**

F99842 SCHWEBETUERENSCHRANK 250 CM H 216CM
PLANKENEICHE NB + RAH STEEL
PLANKENEICHE NACHBILDUNG

202320301107241476000001

Paket / Package / Paquet

414760

SOCKEL

Paket 1 von 8 Colli Kommission 10

HSP-SHT BOD 50 TEXT/TEX SOCKEL 32 FRESH TV / LF 104
SO-BOD TEXT RASTEX/ ZNBOD D18MM TX KLSTA

Montage - Anleitung Laenge 520,0 OBEREN
KS-64 Breite 568,0 OBEREN

SOCKEL32 KLEB

En cas de dommage, veuillez retourner le carton avec le produit. En cas de dommage, veuillez retourner le carton avec le produit.



OBEREN 5 30/19 HAUT 23.08.19 OBEREN 1 1. JABOVE OBEREN



WIMEX Wohnbedarf
Import Export Handelsges mbH & Co. KG
Werner-von-Siemens-Str. 35
D-49124 Georgsmarienhütte - Germany

SAMPLE **23.08.19**
Modellname Produktionsdatum
Model Date of manufacture

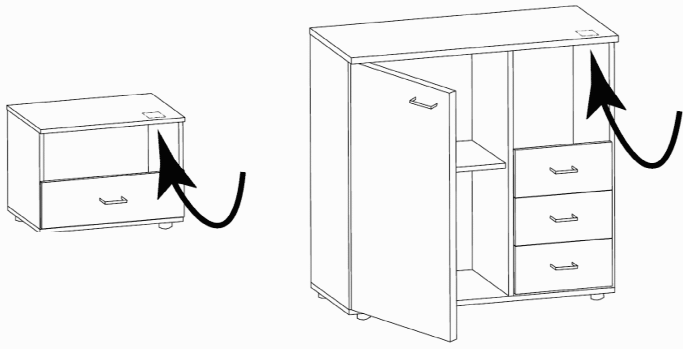
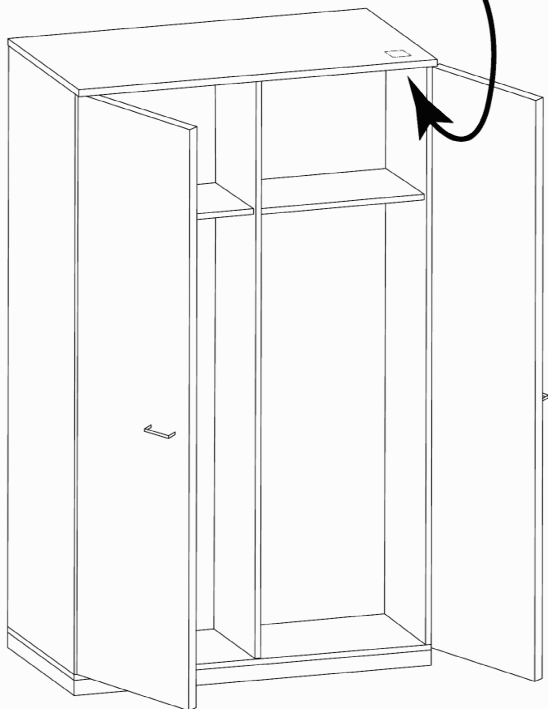
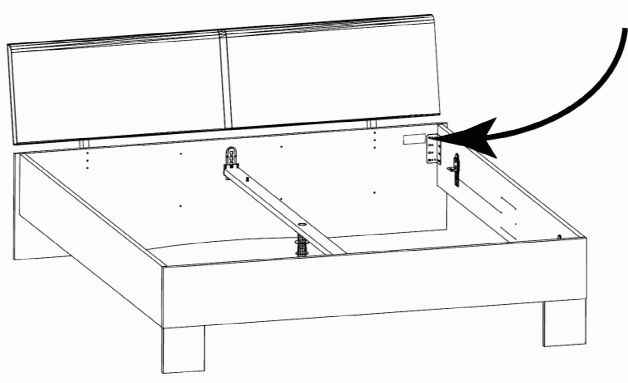

980830



1.

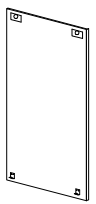

2.

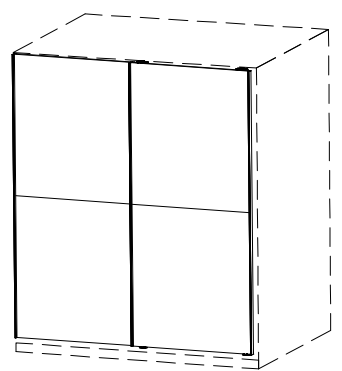
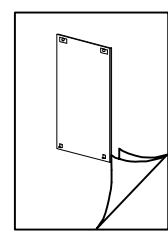
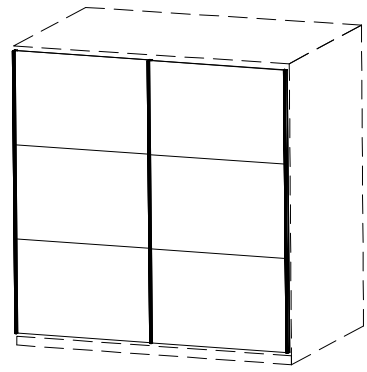
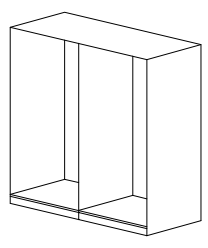

150/200/250/300 HSP

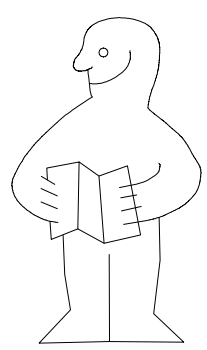
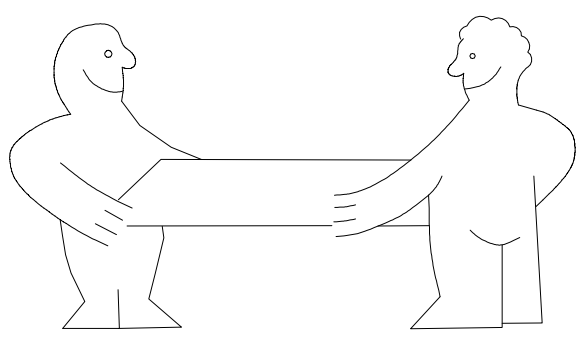
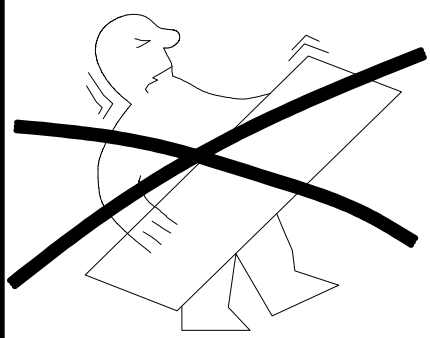

1-2-3-4... ○

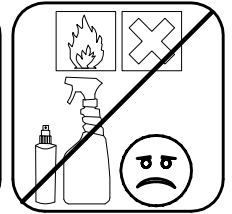
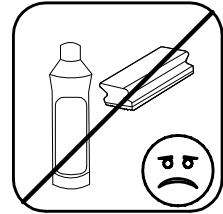
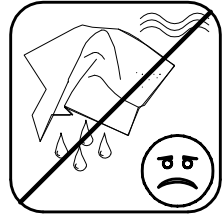
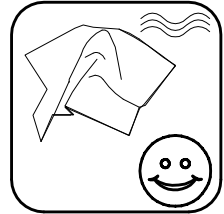
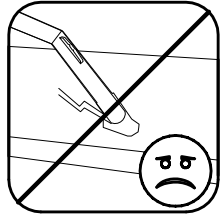
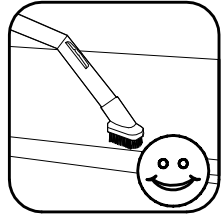
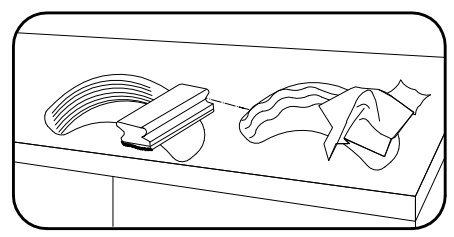
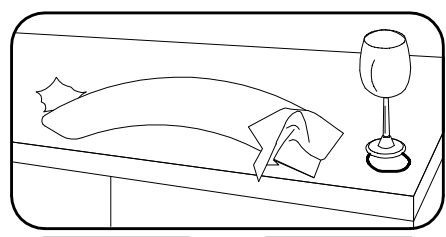
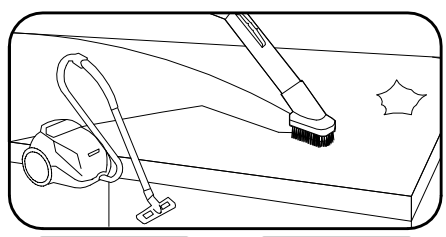
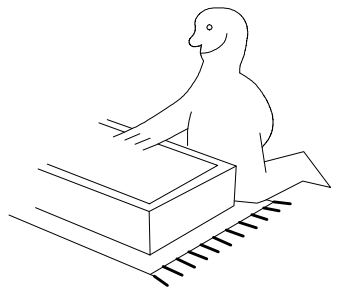
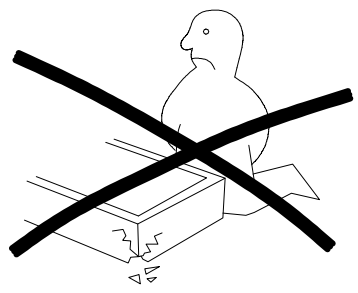
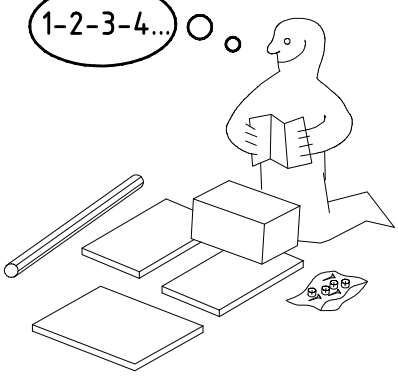





980830

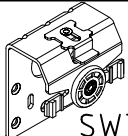

26.11.16 / -

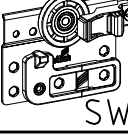
11 16

1/11

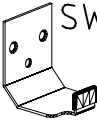
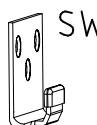
 SWT 1	2x
 SWT 2	1x
 SWT 8	1x

3,5 x 15 mm  G1 121 370	1x
 SWH 6	2x
 SWH 7	2x

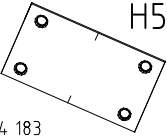
4 X 13mm  SP13 121 122	60x 68x
6,3 x 10,5 mm  T2 111 030	24x
 H5 114 183	2x 4x

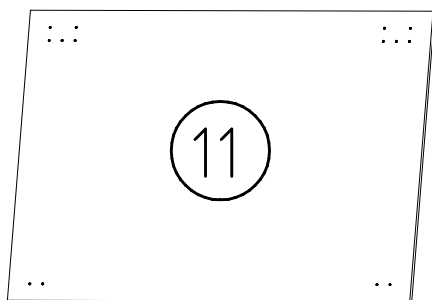
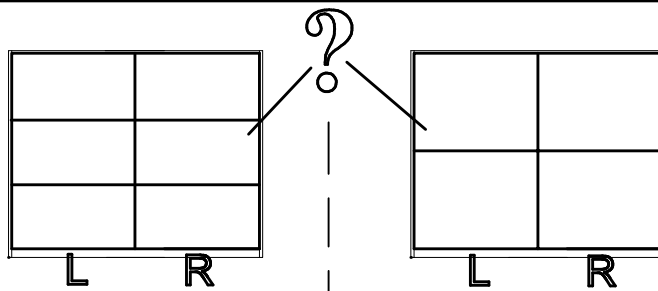
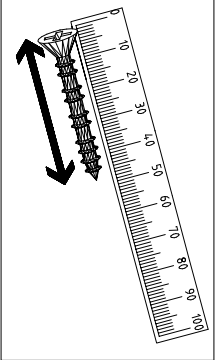
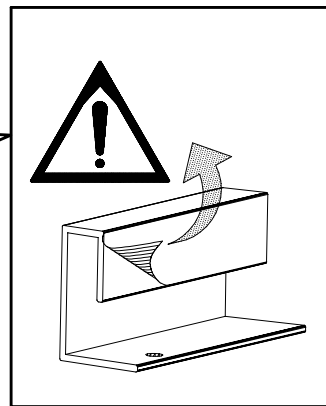
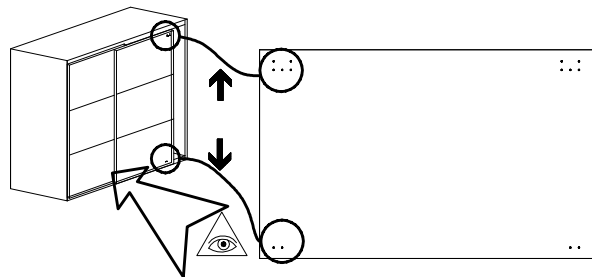
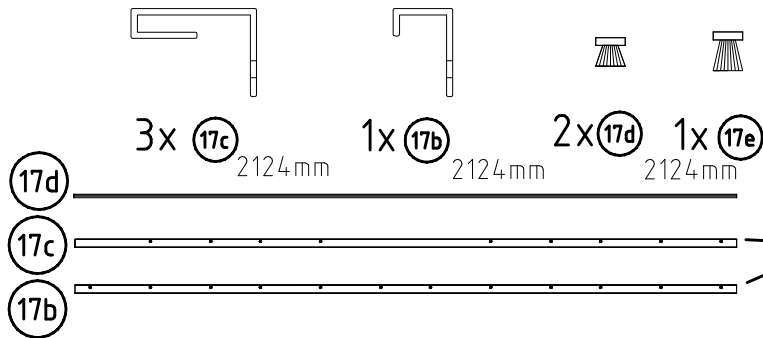
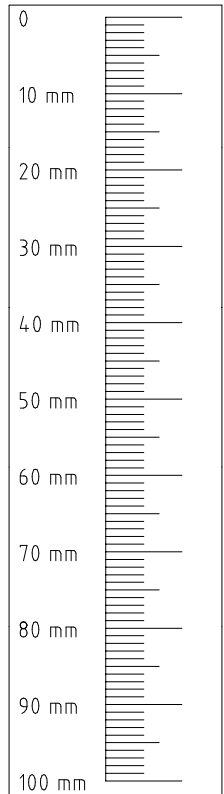
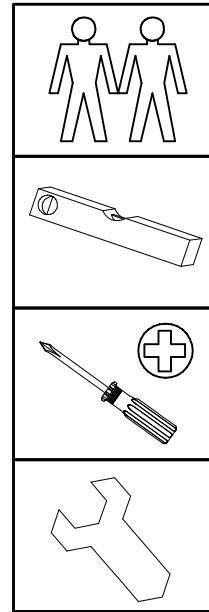

6x 745/990/1235/1485 x 708 x 15

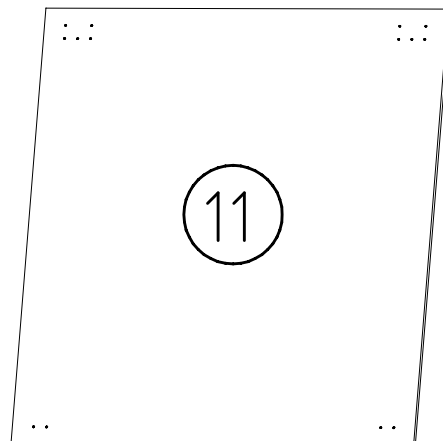
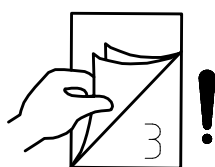

4x 745/990/1235/1485 x 1062 x 15

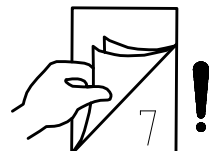

1

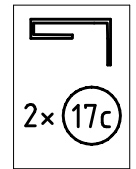
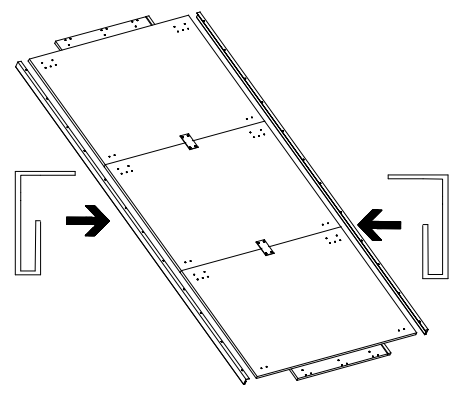
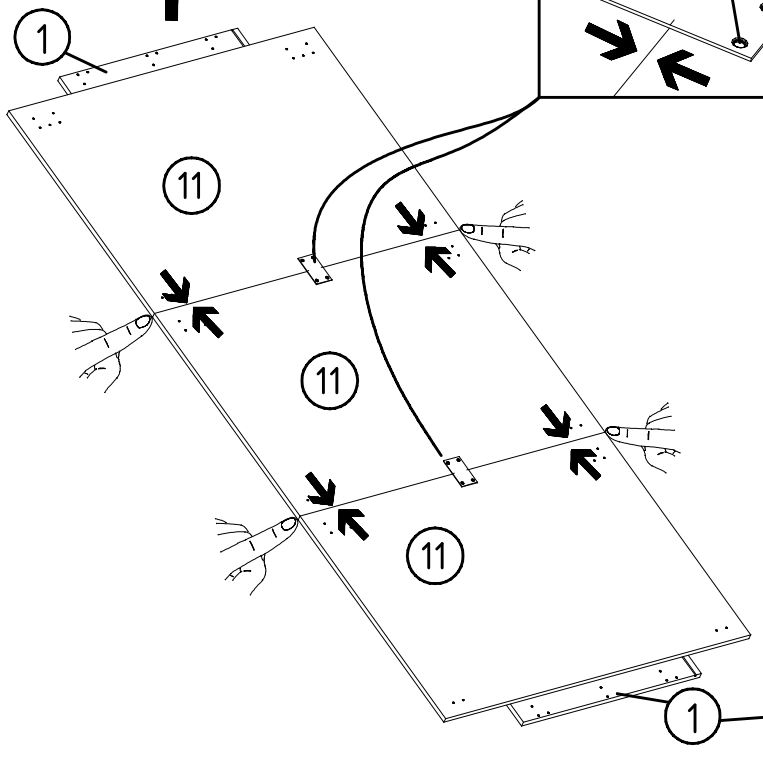
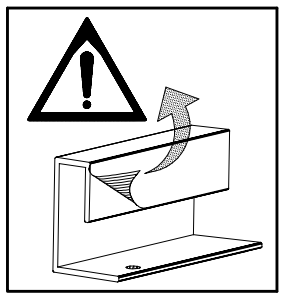
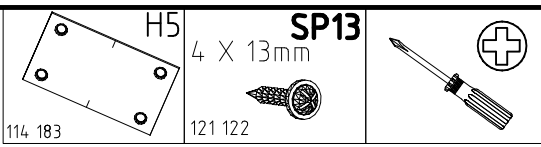
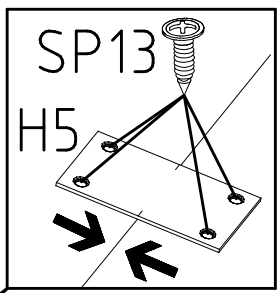
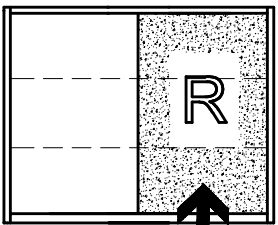

2

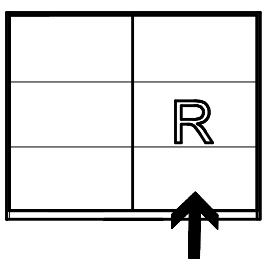
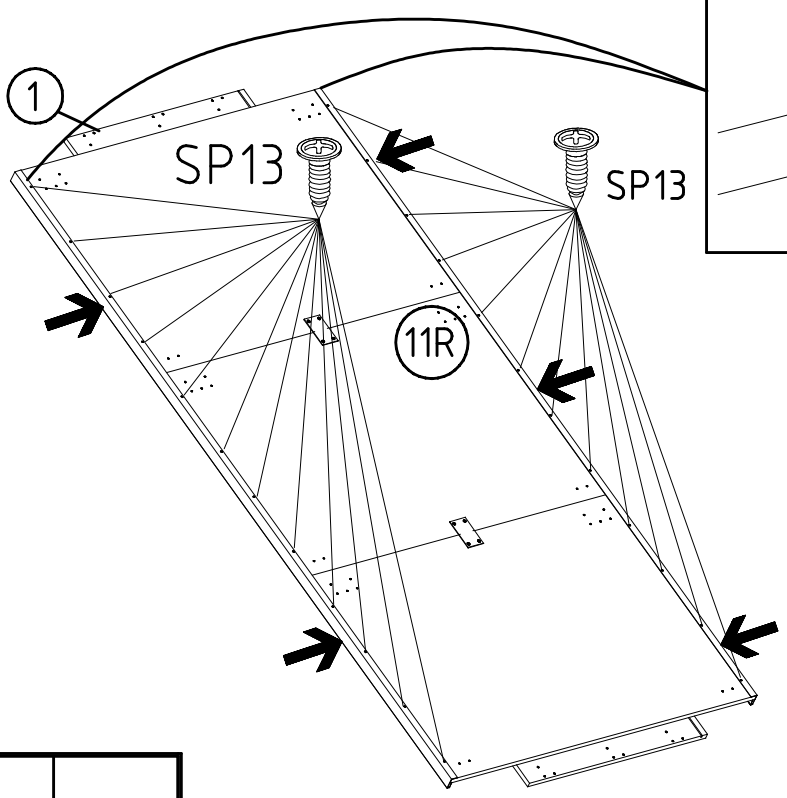
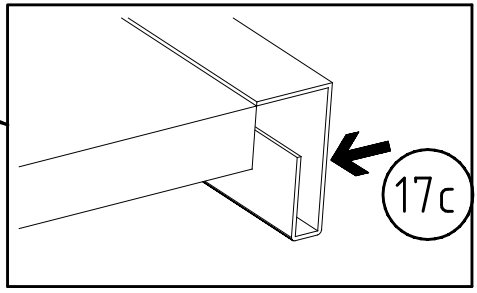
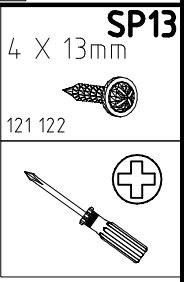

3

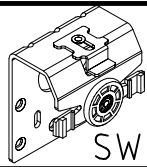

SWT 1

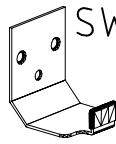

SWH 6

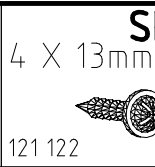

SP13

4 X 13mm

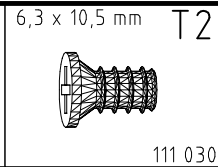

6,3 x 10,5 mm T2

111 030

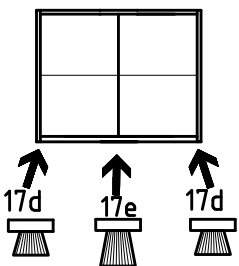
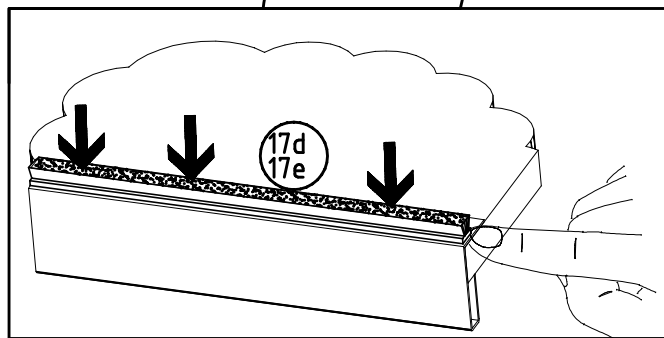
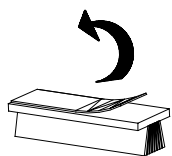
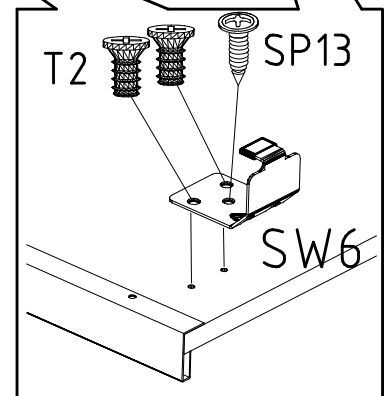
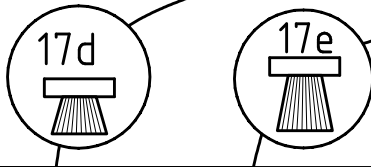
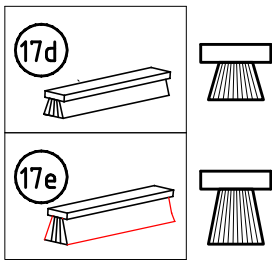
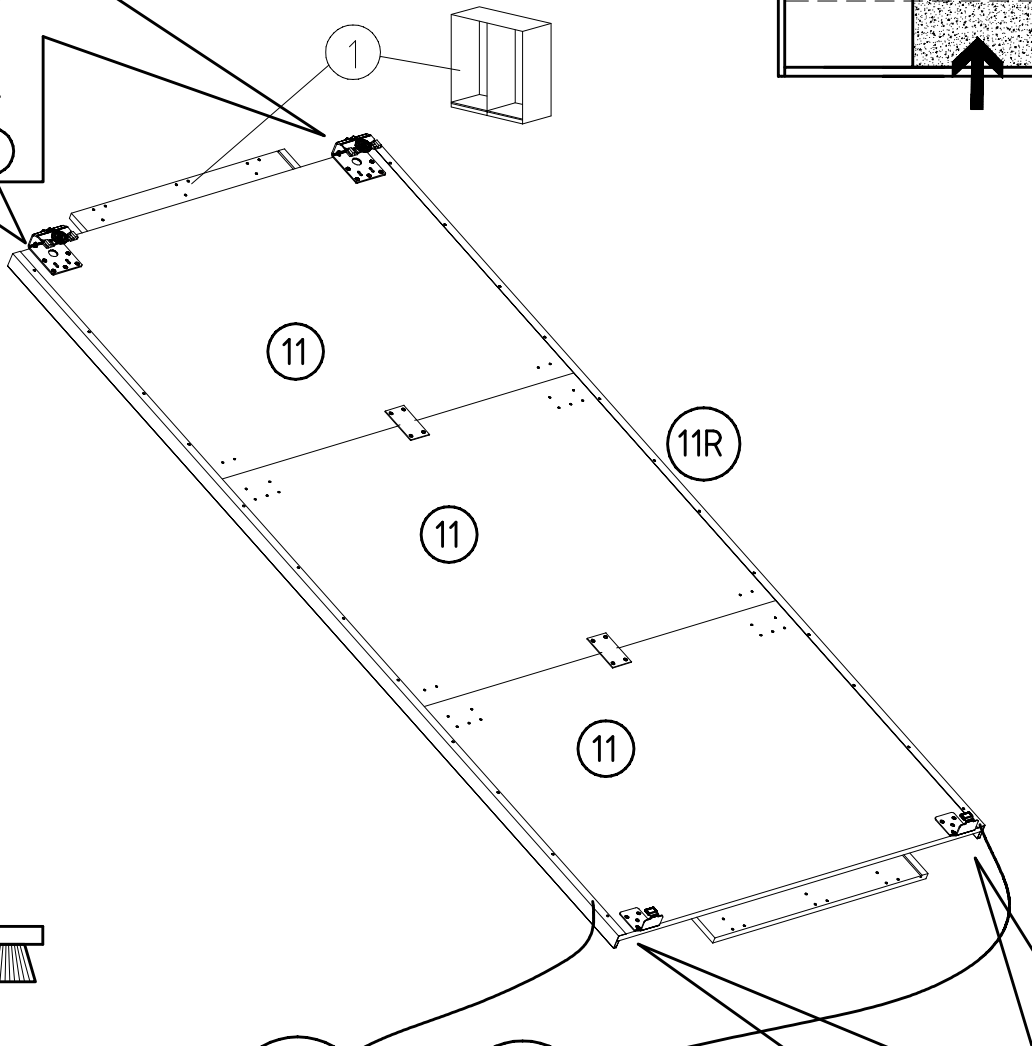
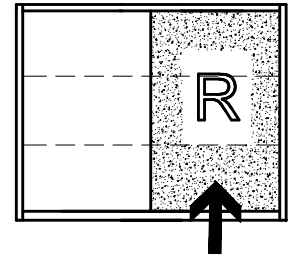
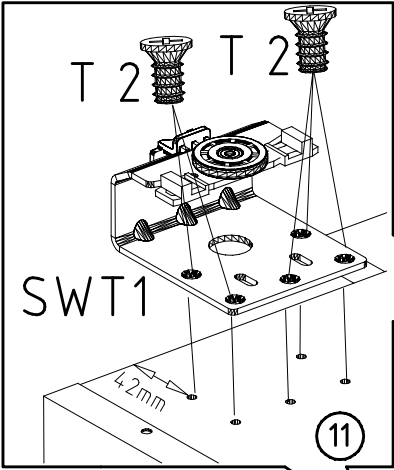
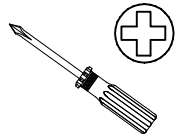

4

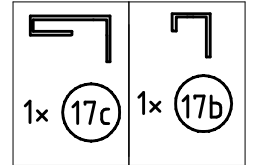
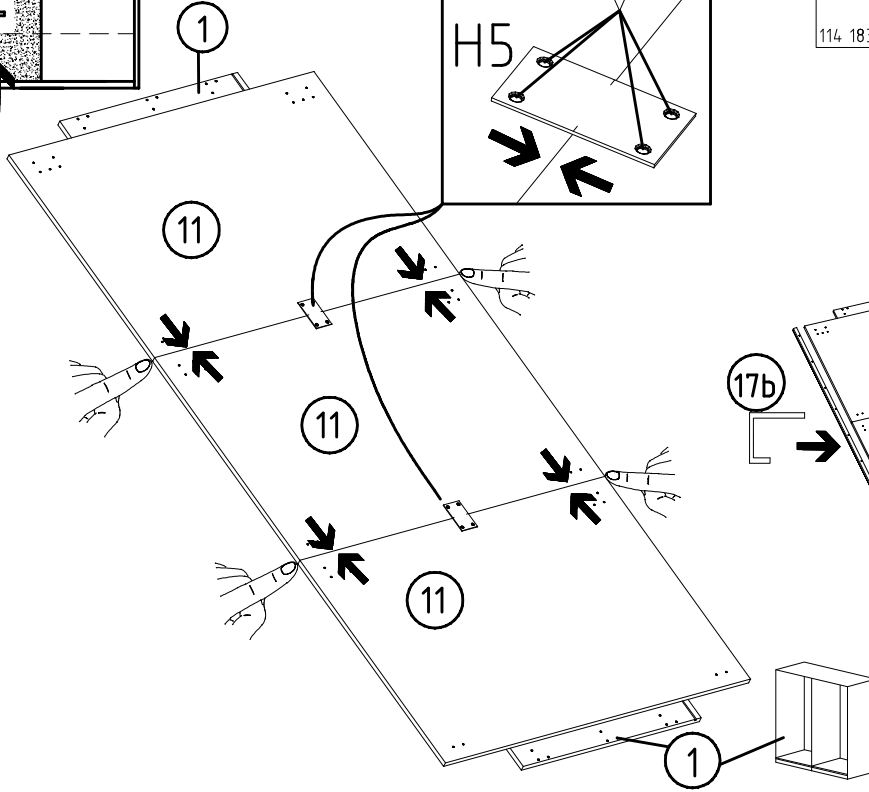
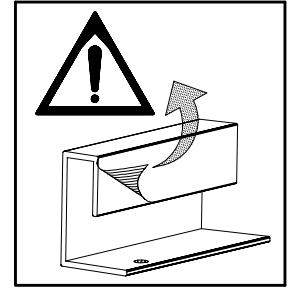
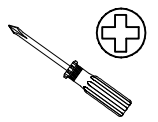
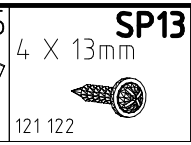
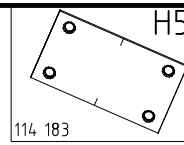
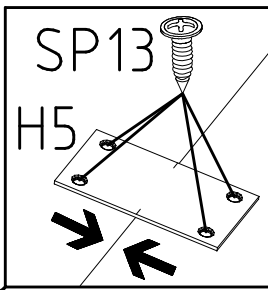
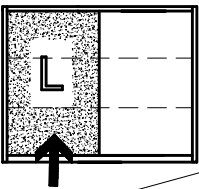

5

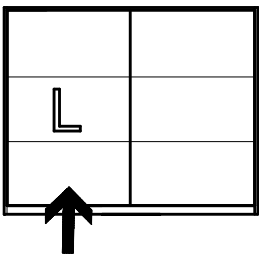
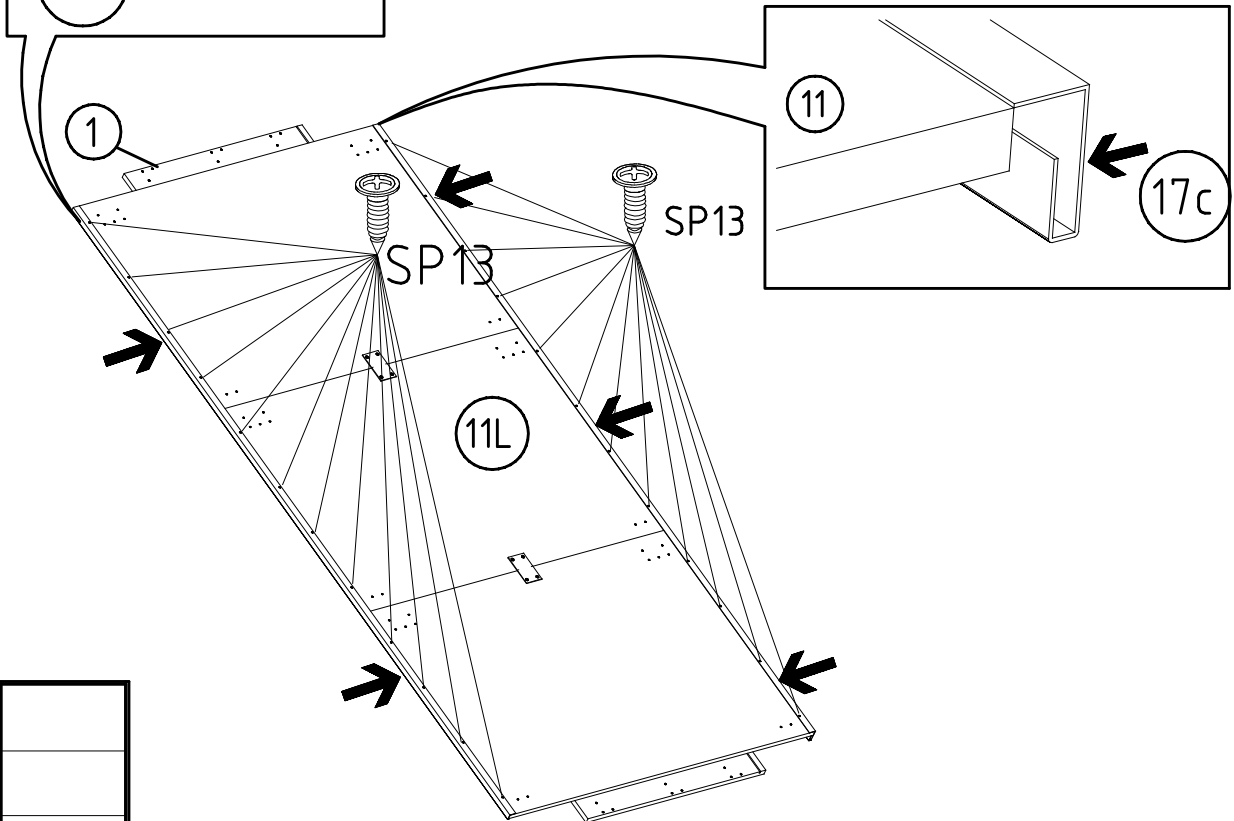
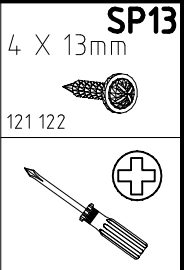
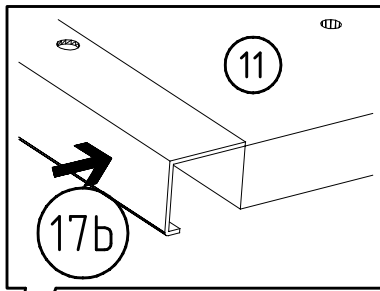

6

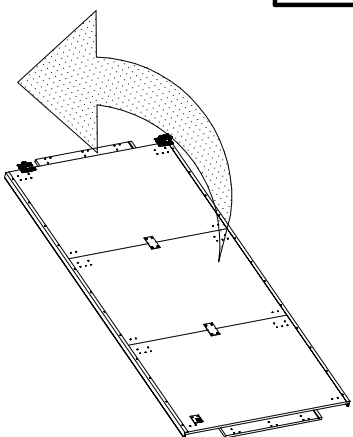
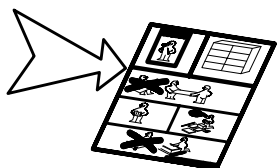
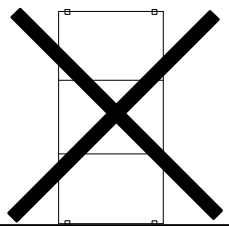
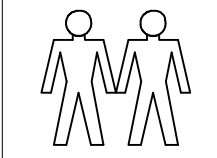
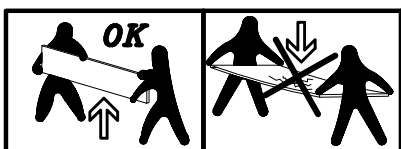
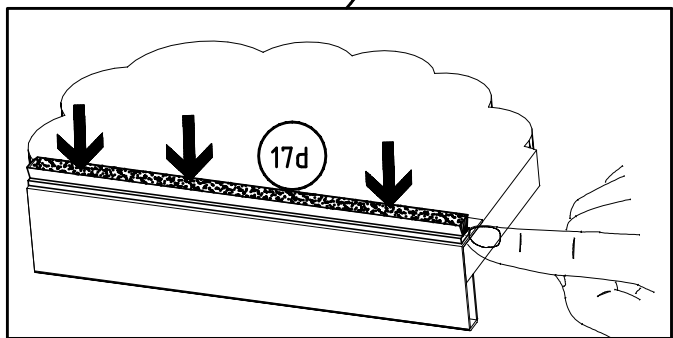
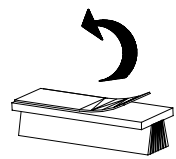
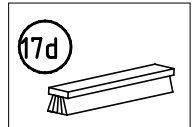
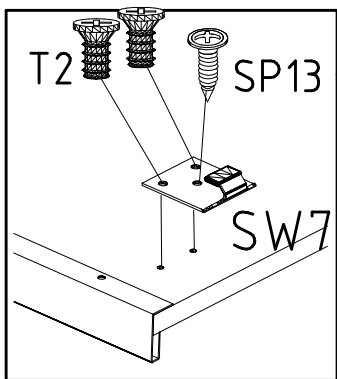
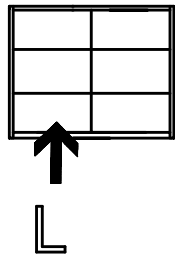
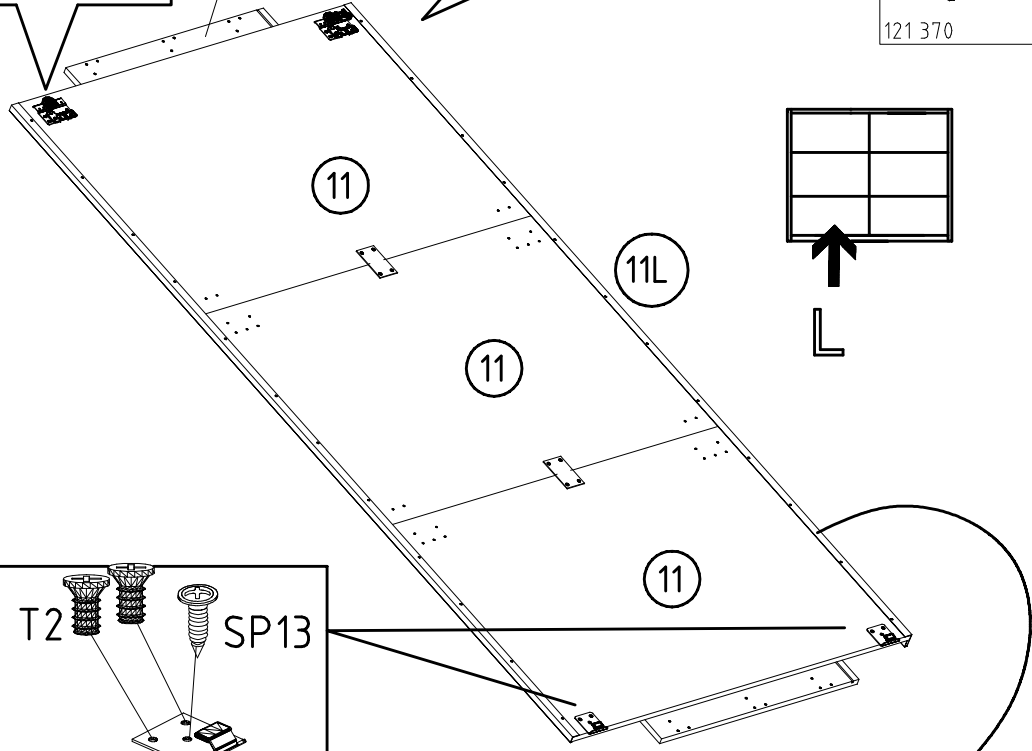
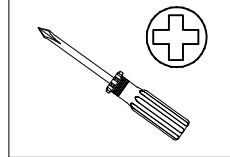
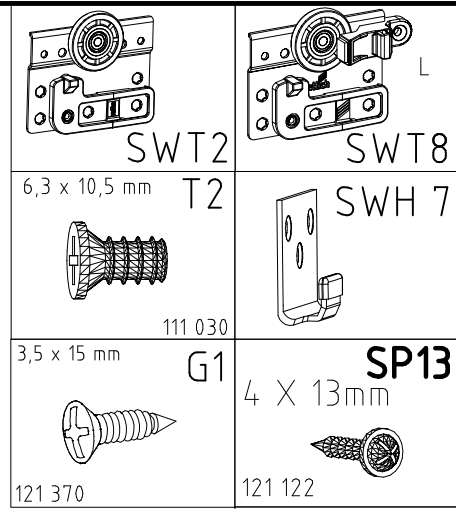
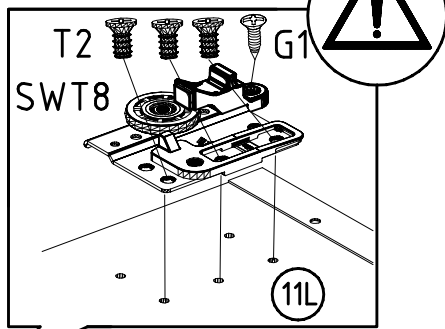
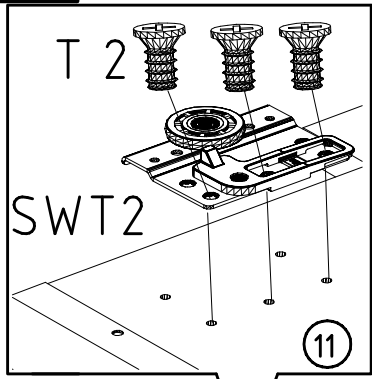

1

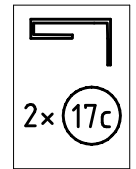
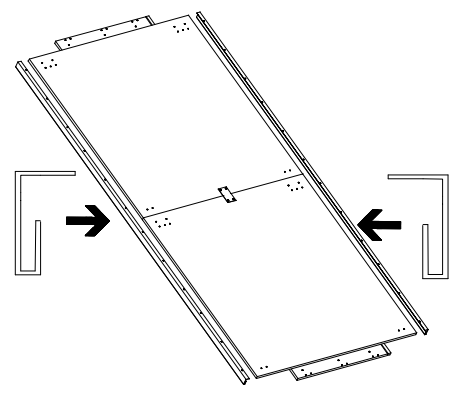
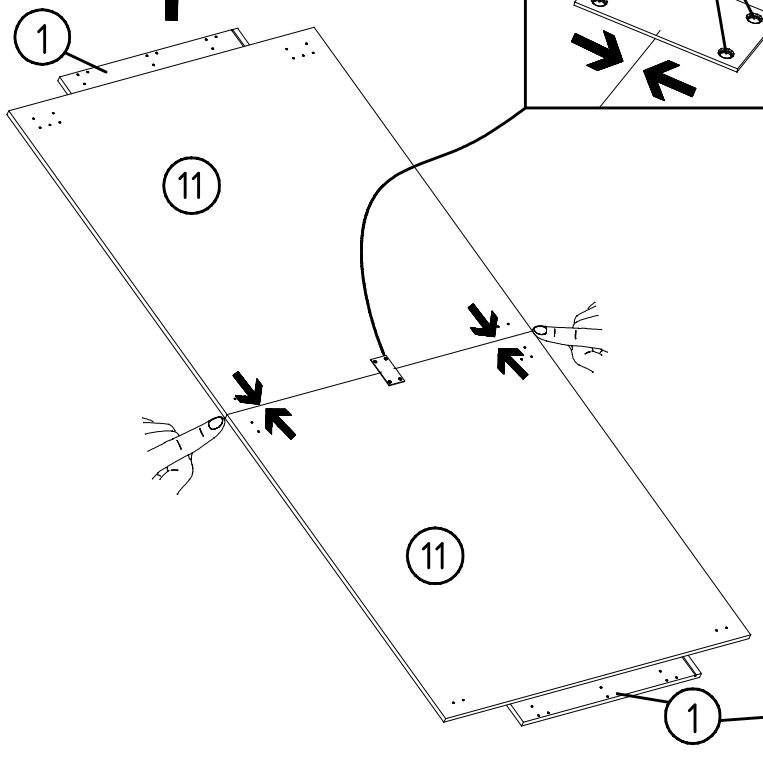
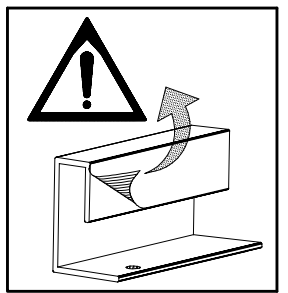
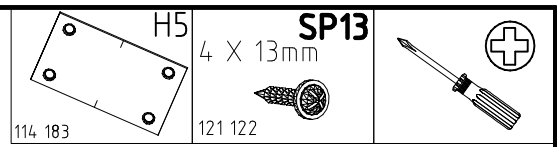
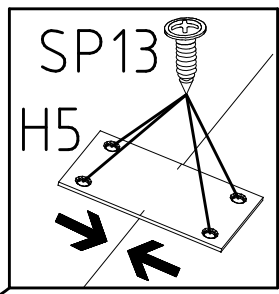
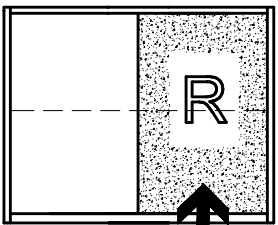

2

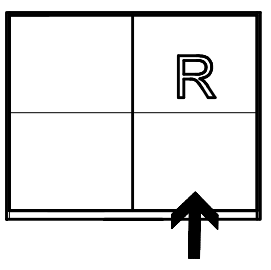
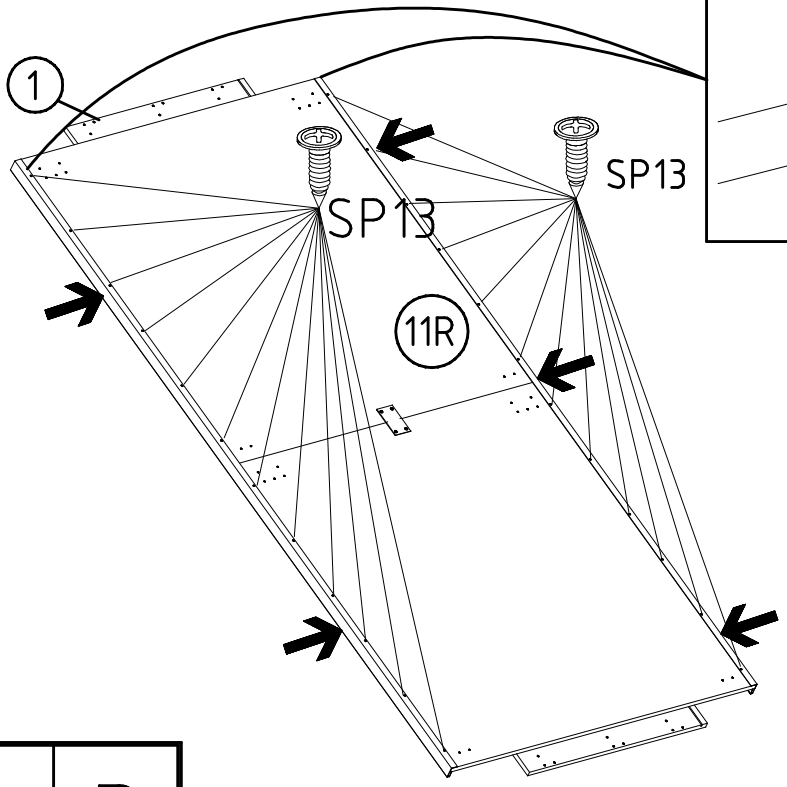
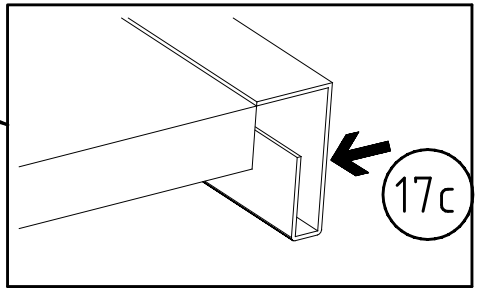
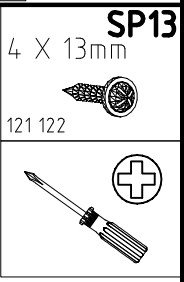

3

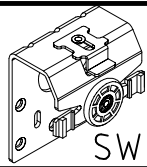

SWT 1

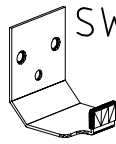

SWH 6

4 X 13mm

SP13

121 122



6,3 x 10,5 mm T2

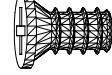

111 030

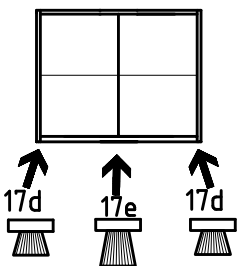
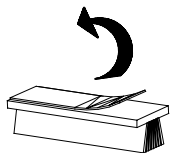
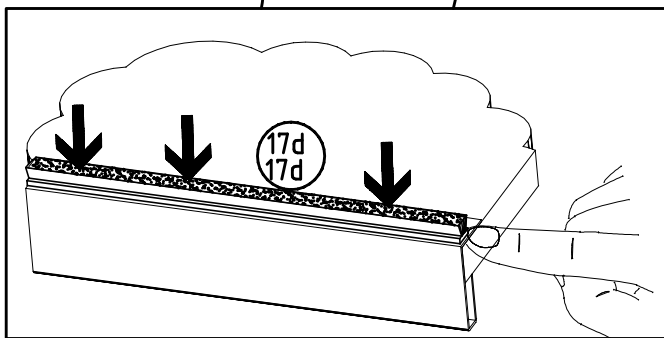
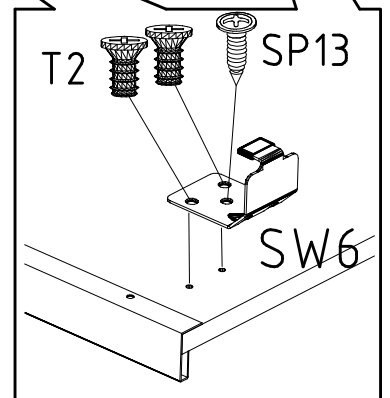
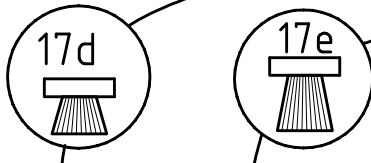
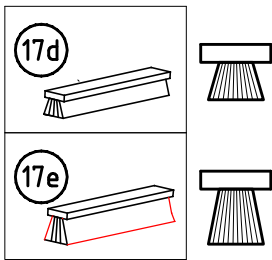
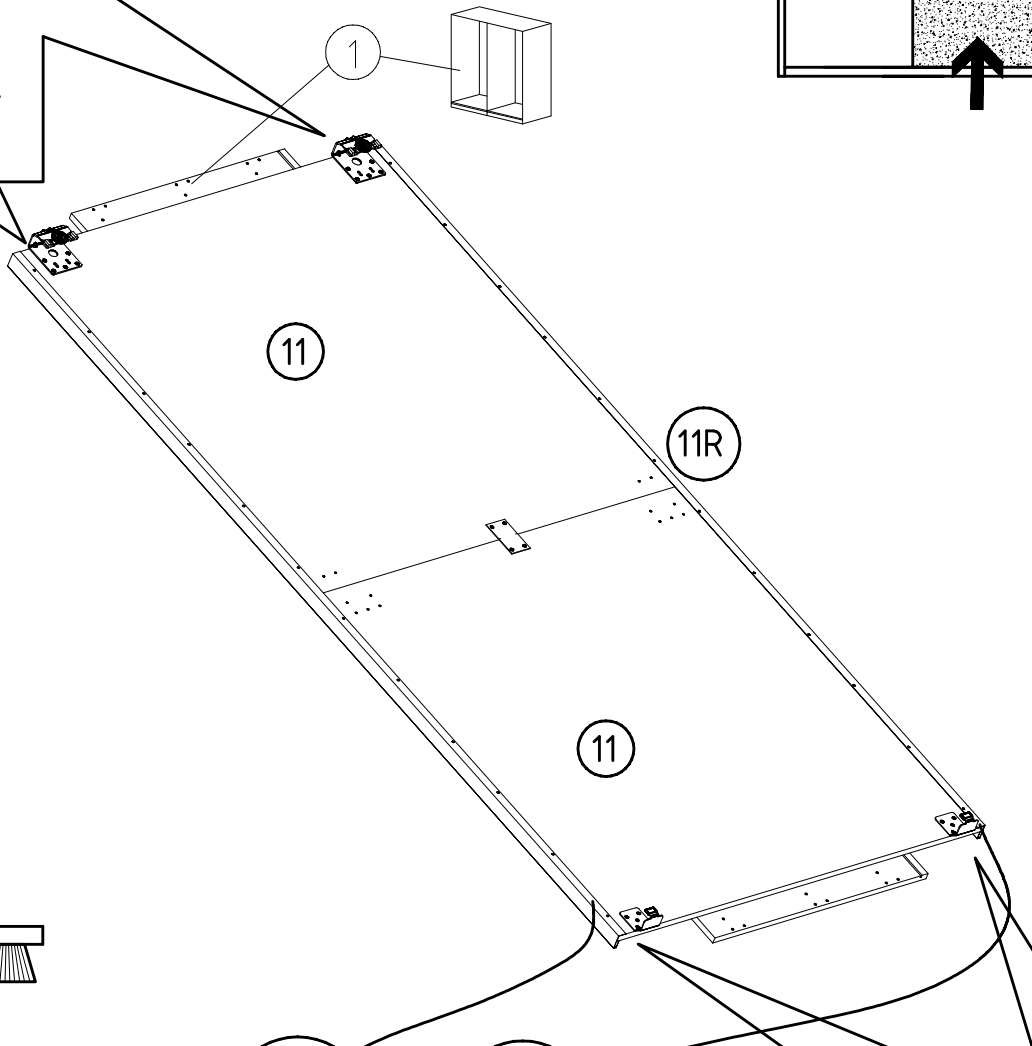
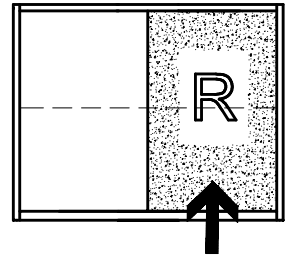
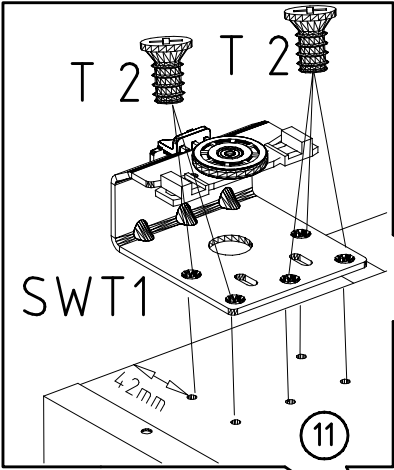
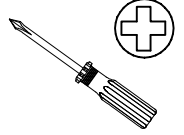

4

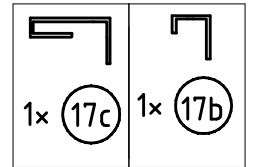
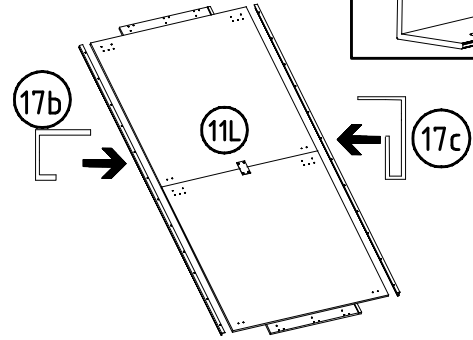
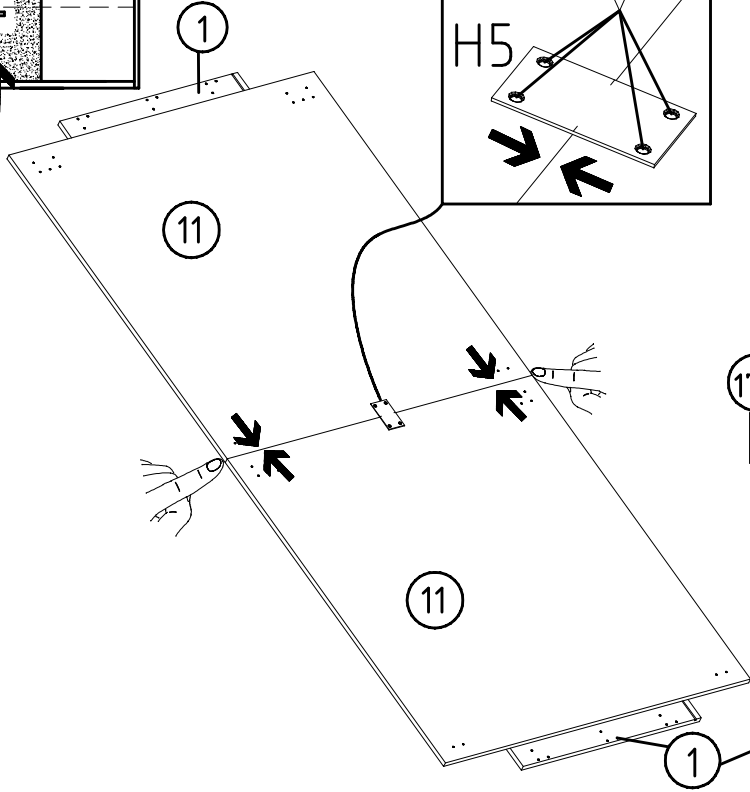
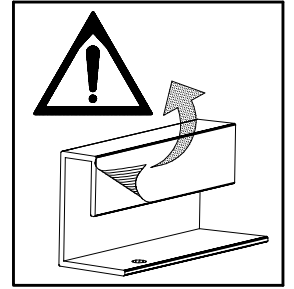
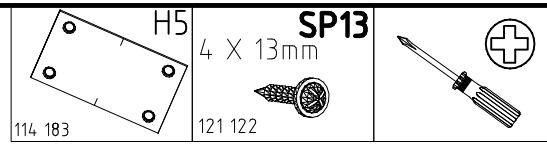
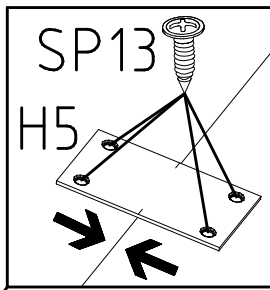
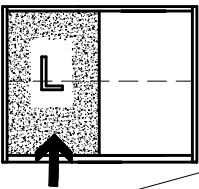

5

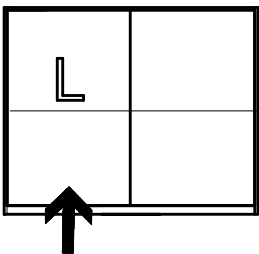
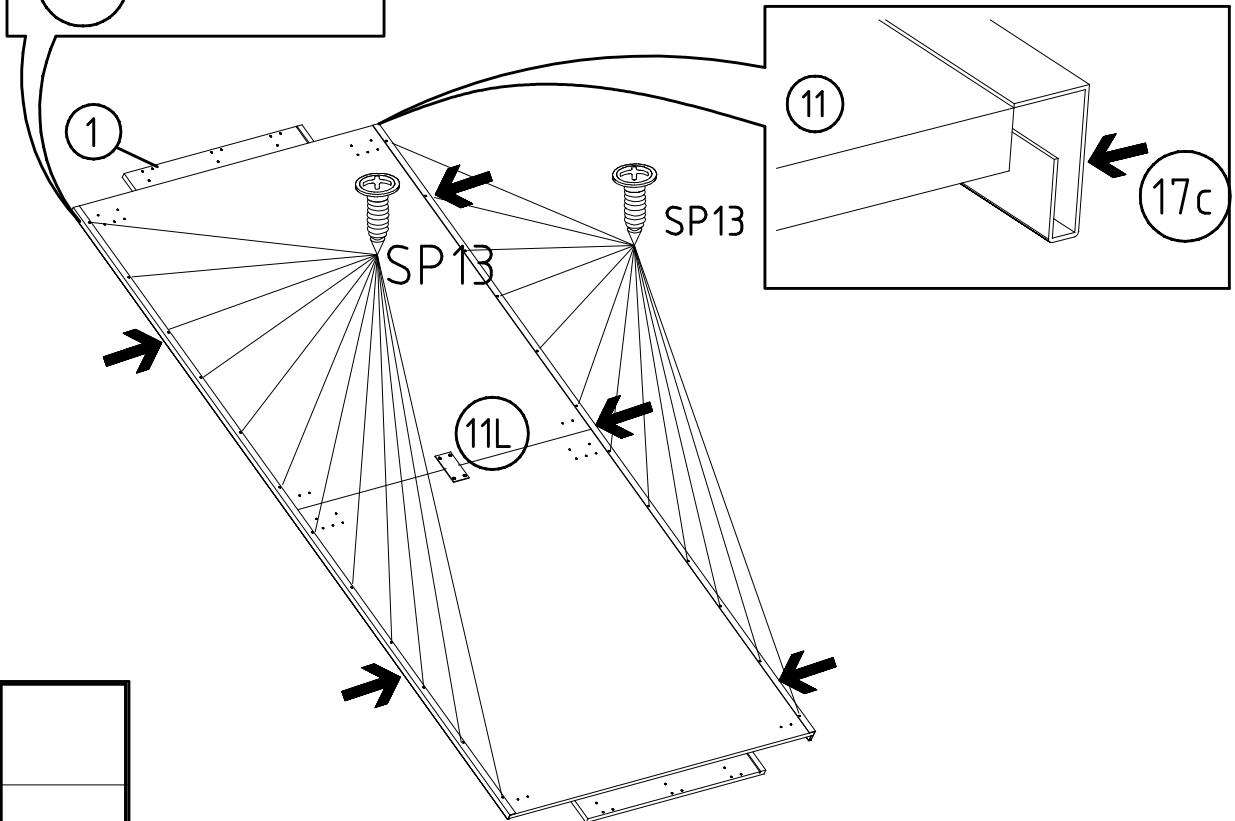
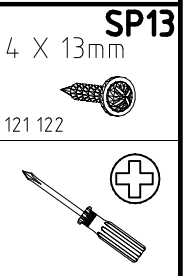
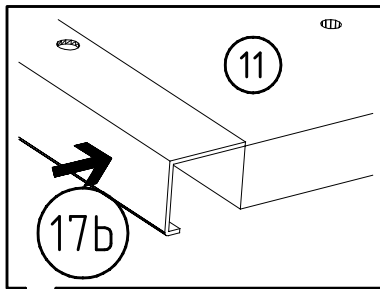

6

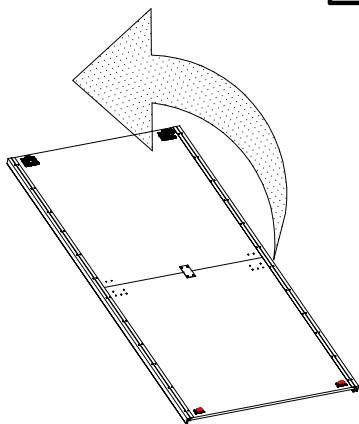
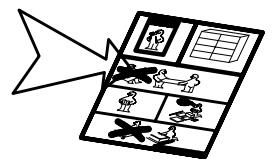
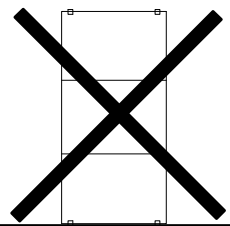
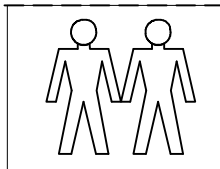
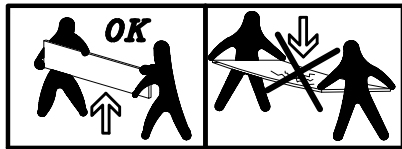
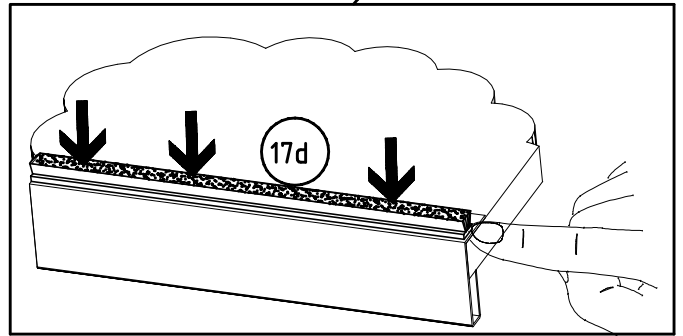
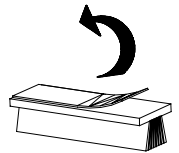
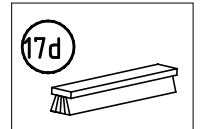
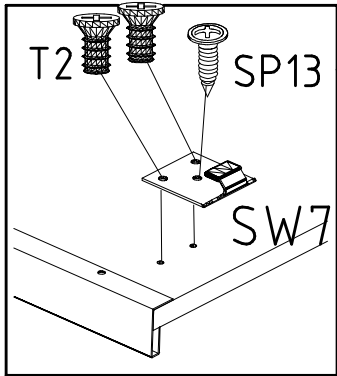
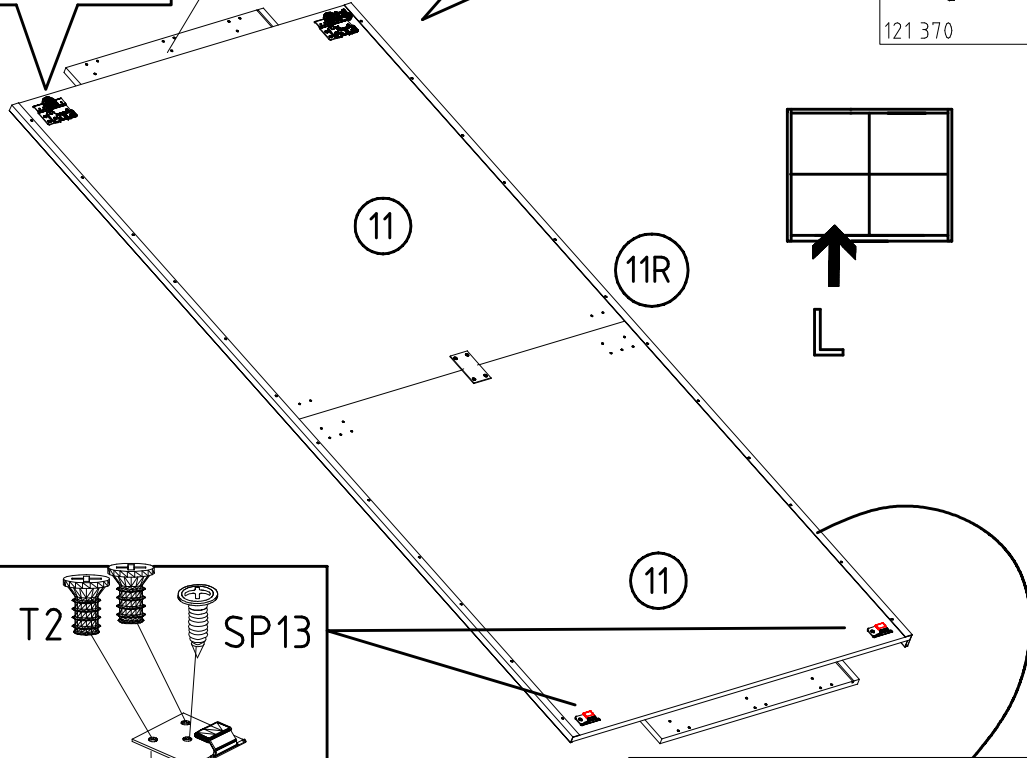
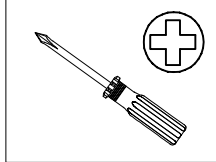
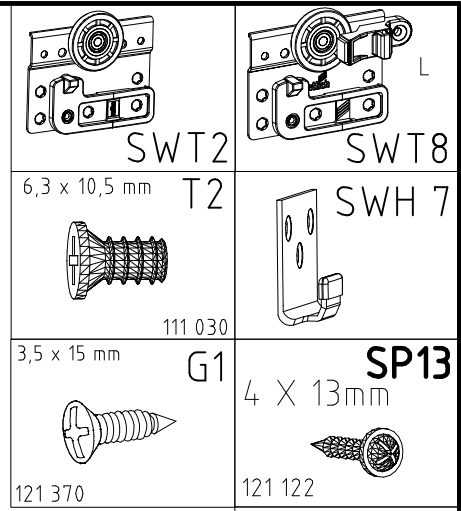
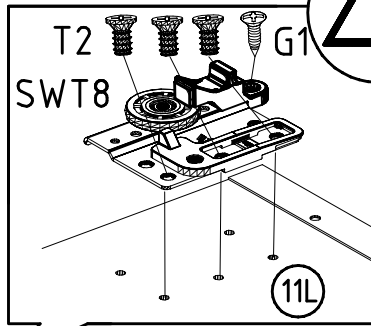
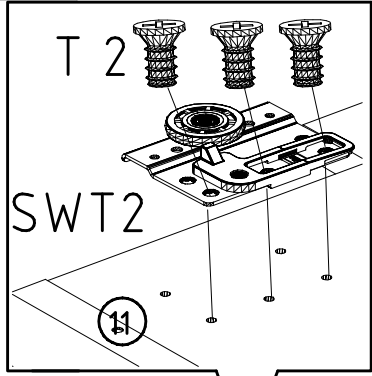

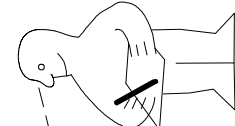
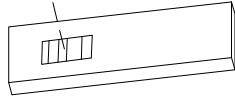
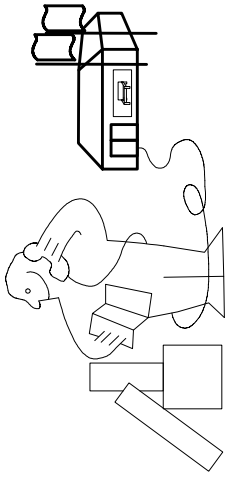
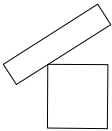
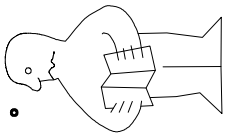

Modell/Model/Modèle



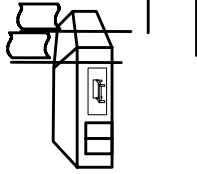

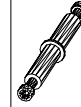
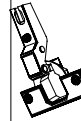
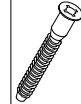

{121 370}

{ G 1 }

{4x}

Änderungen die dem technischen Fortschritt geschuldet sind, behalten wir uns vor !

Bei nicht vorschriftsmäßiger und/ oder nicht fachmännischer Montage wird bei Personen- und/ oder Sachschäden keinerlei Haftung übernommen.

WIMEX Wohnbedarf/ Import Export Handels GmbH/ Postfach 1407/ 49112 Georgsmarienhütte/ Germany
Tel.:(+49) 054-01 8598 16/17 Fax.:(+49) 054-01 8598 33 Mail: service_H@wimex-online.com

104P-Nr. / 104P-No. 150X-Nr. / 150X-No. Auftrag/Order-No. / No. de Commande

23203 **30110XY** 104

Kunde MAX MUSTERMANN
Customer
Client

Kommission / your order reference / votre reference

3377 MINDEN

Dekor / Decor Decor / Modell / Modele

F99 **SAMPLE**

F99842 SCHWEBETUERENSCHRANK 250 CM H 216CM
PLANKENEICHE NB + RAH STEEL
PLANKENEICHE NACHBILDUNG

202320301107241476000001

Paket / Package / Paquet

414760

SOCKEL

Paket 1 von 8 Colli Kommission 10

HSP-SHT BOD 50 TEXT/TEX SOCKEL 32 FRESH TV / LF 104
SO-BOD TEXT RASTEX/ ZNBOD D18MM TX KLSTA

Montage - Anleitung Laenge 520,0 OBEREN
KS-64 Breite 568,0 OBEREN

SOCKEL32 KLEB

Bei Warenauslieferung für Rückgabe beachten!
En cas de livraison veuillez retourner le bordereau d'envoi.



OBEREN 5 30/19 HAUT 23.08.19 OBEREN 1 1. JABOVE OBEREN



WIMEX Wohnbedarf
Import Export Handelsges mbH & Co. KG
Werner-von-Siemens-Str. 35
D-49124 Georgsmarienhütte - Germany

SAMPLE **23.08.19**
Modellname Produktionsdatum
Model Date of manufacture

